

1.5A, 17V, 340/800kHz Synchronous Step-Down Converter

General Description

The RT8297A/B is a high efficiency, monolithic synchronous step-down DC-DC converter that can operate at 340kHz/800kHz, while delivering up to 1.5A output current from a 4V to 17V input supply. The RT8297A/B's current mode architecture allows the transient response to be optimized. Cycle-by-cycle current limit provides protection against shorted outputs and soft-start eliminates input current surge during start-up. Fault conditions also include output under voltage protection, output over voltage protection, and thermal shutdown. The low current (<5 μ A) shutdown mode provides output disconnect, enabling easy power management in battery-powered systems. The RT8297A/B is available in a WDFN-8L 2x2 package.

Ordering Information

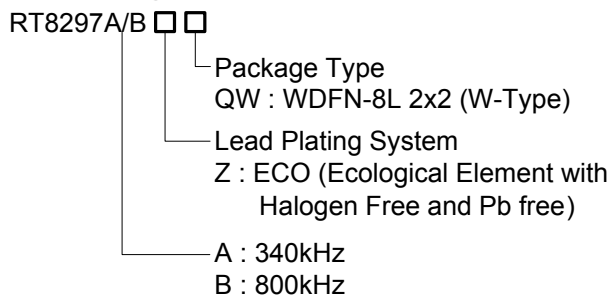

Note :

Richtek products are :

- ▶ RoHS compliant and compatible with the current requirements of IPC/JEDEC J-STD-020.
- ▶ Suitable for use in SnPb or Pb-free soldering processes.

Marking Information

RT8297AZQW

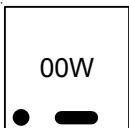

00 : Product Code
W : Date Code

RT8297BZQW

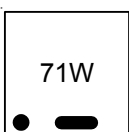

71 : Product Code
W : Date Code

Features

- 4V to 17V Input Voltage Range
- 1.5A Output Current
- Internal N-MOSFETs
- Current Mode Control
- Fixed Frequency Operation : 340kHz/800kHz
- Output Adjustable from 0.8V to 12V
- Up to 95% Efficiency
- Internal Compensation
- Stable with Low ESR Ceramic Output Capacitors
- Cycle-by-Cycle Over Current Protection
- Input Under Voltage Lockout
- Output Under Voltage Protection
- Output Over Voltage Protection
- Power Good Indicator
- Thermal Shutdown Protection
- RoHS Compliant and Halogen Free

Applications

- Industrial and Commercial Low Power Systems
- Computer Peripherals
- LCD Monitors and TVs
- Green Electronics/Appliances
- Point of Load Regulation for High-Performance DSPs, FPGAs, and ASICs

Pin Configuration

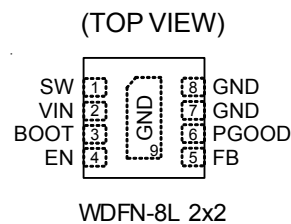

Typical Application Circuit

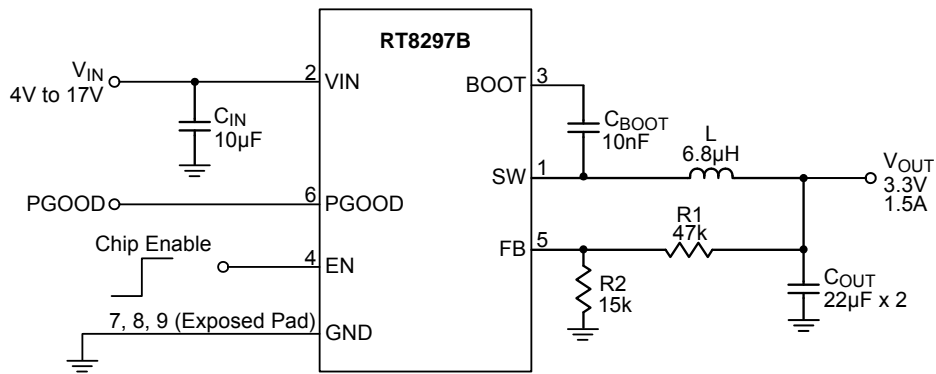
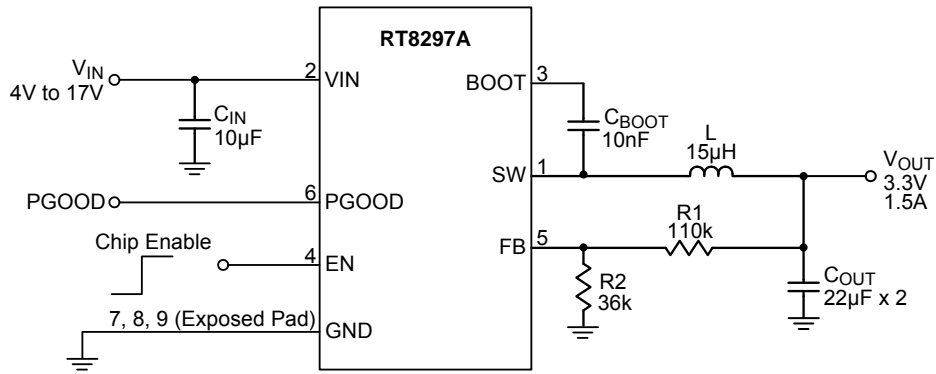

Table 1. Recommended Component Selection

RT8297A

V _{OUT} (V)	L (µH)	R1 (kΩ)	R2 (kΩ)	C _{OUT} (µF)
1.2	4.7	110	220	22 x 2
2.5	10	110	51	22 x 2
3.3	15	110	36	22 x 2
5	22	120	22	22 x 2

RT8297B

V _{OUT} (V)	L (µH)	R1 (kΩ)	R2 (kΩ)	C _{OUT} (µF)
1.2	3.6	47	91	22 x 2
2.5	4.7	47	22	22 x 2
3.3	6.8	47	15	22 x 2
5	10	62	12	22 x 2

Functional Pin Description

Pin No.	Pin Name	Pin Function
1	SW	Switch node. Connect to external L-C filter.
2	VIN	Input supply voltage. Must bypass with a suitably large ceramic capacitor.
3	BOOT	Bootstrap for high side gate driver. Connect 0.01 μ F or greater ceramic capacitor from BOOT to SW pin.
4	EN	Chip enable. A logic-high enables the converter; a logic-low forces the RT8297A/B into shutdown mode, reducing the supply current to less than 5 μ A. Attach this pin to VIN with a 100k Ω pull up resistor for automatic startup.
5	FB	Feedback input pin. For an adjustable output, connect an external resistive voltage divider to this pin.
6	PGOOD	Power good indicator. The output of this pin is low if the output voltage is 12.5% less than the nominal voltage. Otherwise, it is an open drain.
7, 8, 9 (Exposed Pad)	GND	Ground. The exposed pad must be soldered to a large PCB and connected to GND for maximum power dissipation.

Functional Block Diagram

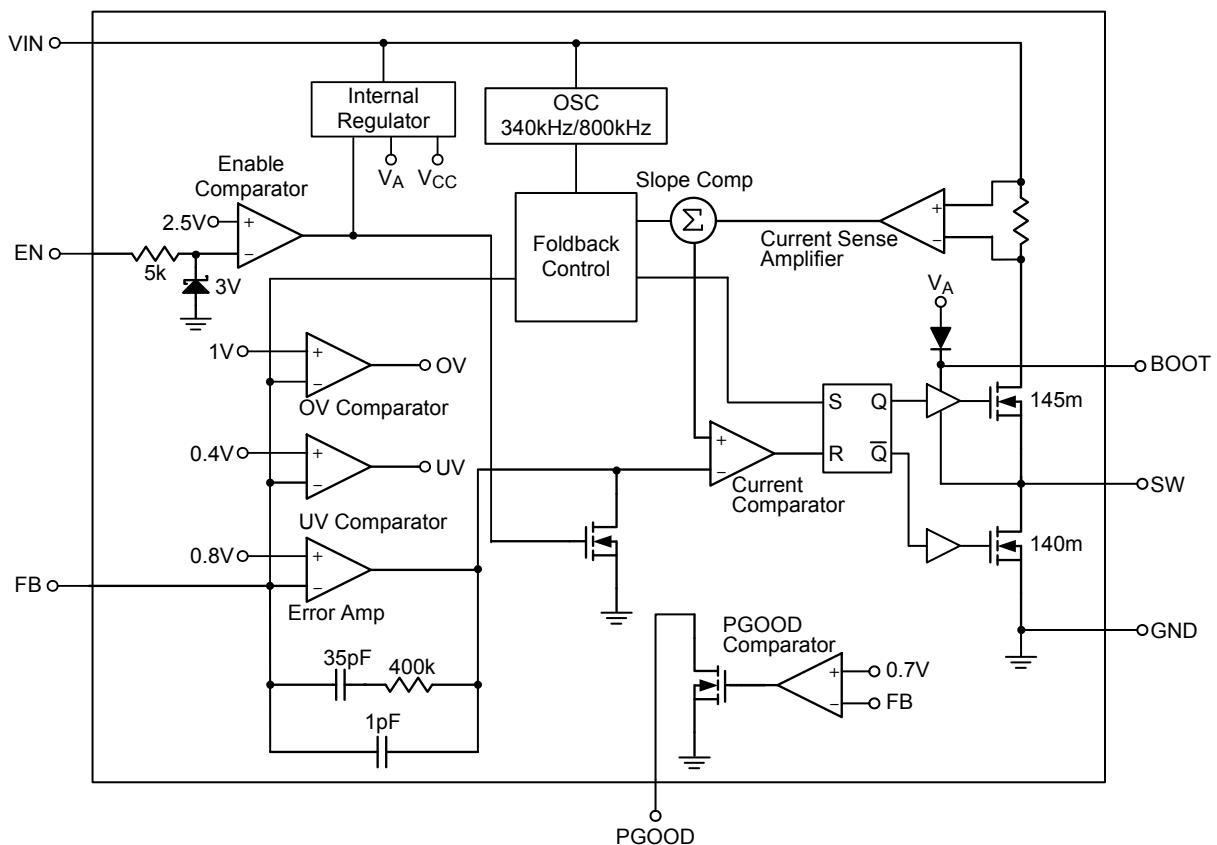

Absolute Maximum Ratings (Note 1)

- Supply Voltage, V_{IN} ----- -0.3V to 19V
- SW ----- -0.3V to ($V_{IN} + 0.3V$)
- BOOT to SW ----- -0.3V to 6V
- All Other Pins ----- -0.3V to 6V
- Power Dissipation, $P_D @ T_A = 25^\circ C$
 WDFN-8L 2x2 ----- 0.833W
- Package Thermal Resistance (Note 2)
 WDFN-8L 2x2, θ_{JA} ----- 120°C/W
 WDFN-8L 2x2, θ_{JC} ----- 8.2°C/W
- Lead Temperature (Soldering, 10 sec.) ----- 260°C
- Junction Temperature ----- 150°C
- Storage Temperature Range ----- -65°C to 150°C
- ESD Susceptibility (Note 3)
 HBM (Human Body Model) ----- 2kV
 MM (Machine Model) ----- 200V

Recommended Operating Conditions (Note 4)

- Supply Input Voltage, V_{IN} ----- 4V to 17V
- Junction Temperature Range ----- -40°C to 125°C
- Ambient Temperature Range ----- -40°C to 85°C

Electrical Characteristics

($V_{IN} = 12V$, $T_A = 25^\circ C$, unless otherwise specified)

Parameter	Symbol	Test Conditions	Min	Typ	Max	Unit
Shutdown Supply Current	ISHDN	$V_{EN} = 0V$	--	1	5	μA
Supply Current	I _{OUT}	$V_{EN} = 3V$, $V_{FB} = 0.9V$	--	0.6	1	mA
Feedback Reference Voltage	V _{REF}	$4V \leq V_{IN} \leq 17V$	0.788	0.800	0.812	V
Feedback Current	I _{FB}	$V_{FB} = 0.8V$	--	10	--	nA
High Side Switch On Resistance	R _{DS(ON)1}		--	145	--	m Ω
Low Side Switch On Resistance	R _{DS(ON)2}		--	140	--	m Ω
Upper Switch Current Limit		Min. duty cycle, $V_{BOOT} - V_{SW} = 4.8V$ maximum loading = 1.5A	2.45	3	4.65	A
Lower Switch Current Limit		From drain to source	--	1	--	A
Oscillation Frequency	f _{OSC1}	For RT8297A	300	340	380	kHz
		For RT8297B	700	800	900	
Short-Circuit Oscillation Frequency	f _{OSC2}	$V_{FB} = 0V$, For RT8297A	--	95	--	kHz
		$V_{FB} = 0V$, For RT8297B	--	170	--	
Maximum Duty Cycle	D _{MAX}	$V_{FB} = 0.7V$, For RT8297A	--	93	--	%
		$V_{FB} = 0.7V$, For RT8297B	--	84	--	%

Parameter		Symbol	Test Conditions	Min	Typ	Max	Unit
Minimum On-Time		t _{ON}		--	100	125	ns
Input Under Voltage Lockout Threshold		V _{UVLO}		--	3.5	--	V
Input Under Voltage Lockout Threshold Hysteresis		ΔV _{UVLO}		--	200	--	mV
EN Threshold Voltage	Logic-High	V _{IH}		2.7	--	--	V
	Logic-Low	V _{IL}		--	--	0.4	
EN Pull Low Current			V _{EN} = 2V, V _{FB} = 1V	--	1	--	μA
Soft-Start Period		t _{SS}		--	1	--	ms
Thermal Shutdown		T _{SD}		--	150	--	°C
Thermal Shutdown Hysteresis		ΔT _{SD}		--	15	--	°C
Power Good Threshold Rising				--	0.7	--	V
Power Good Threshold Hysteresis				--	130	--	mV
Power Good Pull Down Resistance				--	12	--	Ω
Output OVP Trip Threshold				--	125	--	%V _{REF}
Output OVP Prop Delay				--	10	--	μs
Output UVP Trip Threshold				--	50	--	%V _{REF}
Output UVP Prop Delay				--	2	--	μs

Note 1. Stresses beyond those listed under “Absolute Maximum Ratings” may cause permanent damage to the device. These are stress ratings only, and functional operation of the device at these or any other conditions beyond those indicated in the operational sections of the specifications is not implied. Exposure to absolute maximum rating conditions may affect device reliability.

Note 2. θ_{JA} is measured at T_A = 25°C on a high effective thermal conductivity four-layer test board per JEDEC 51-7. θ_{JC} is measured at the exposed pad of the package.

Note 3. Devices are ESD sensitive. Handling precaution is recommended.

Note 4. The device is not guaranteed to function outside its operating conditions.

Typical Operating Characteristics

Efficiency vs. Output Current

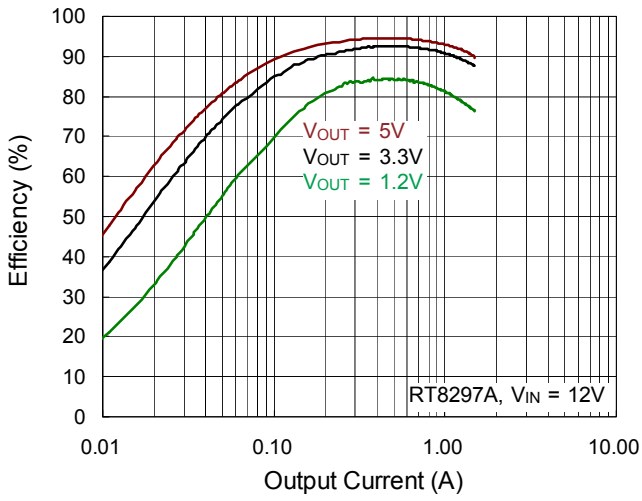

Efficiency vs. Output Current

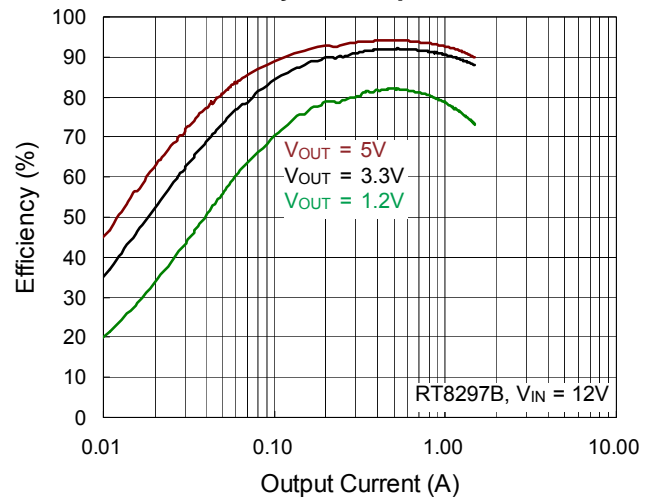

Output Voltage vs. Output Current

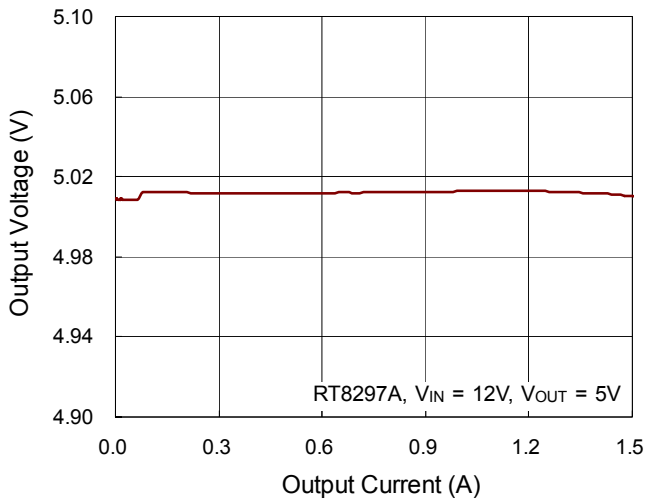

Output Voltage vs. Output Current

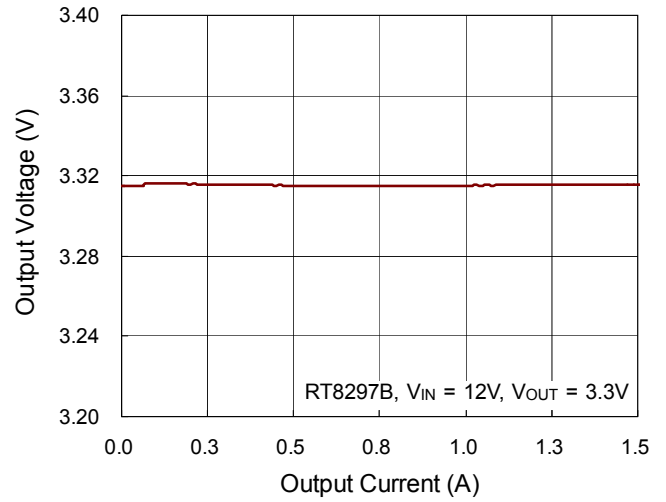

Reference Voltage vs. Temperature

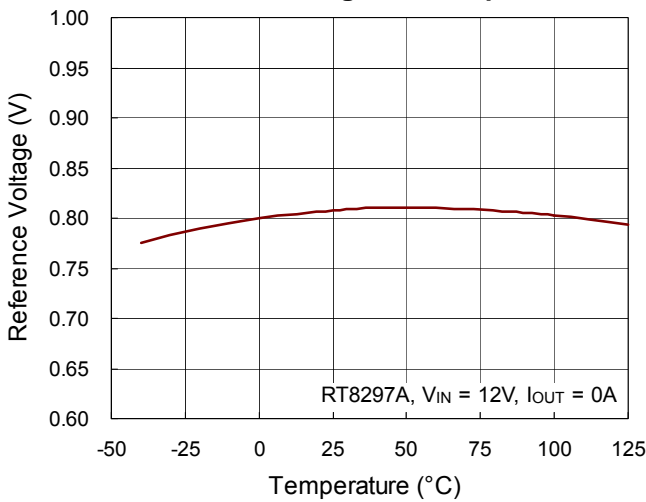

Reference Voltage vs. Temperature

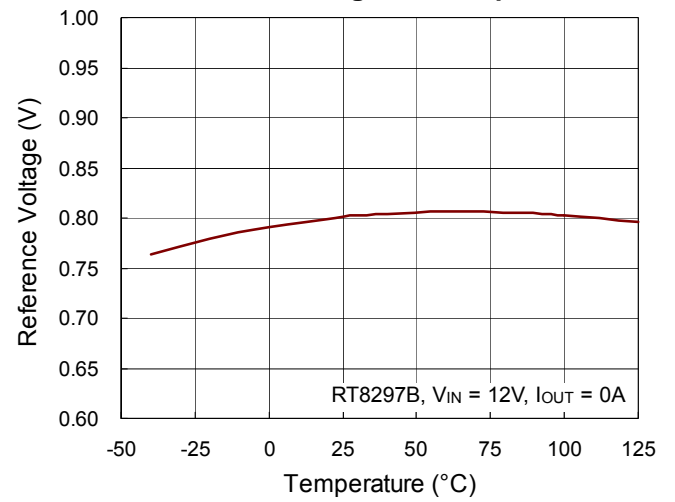

Frequency vs. Input Voltage

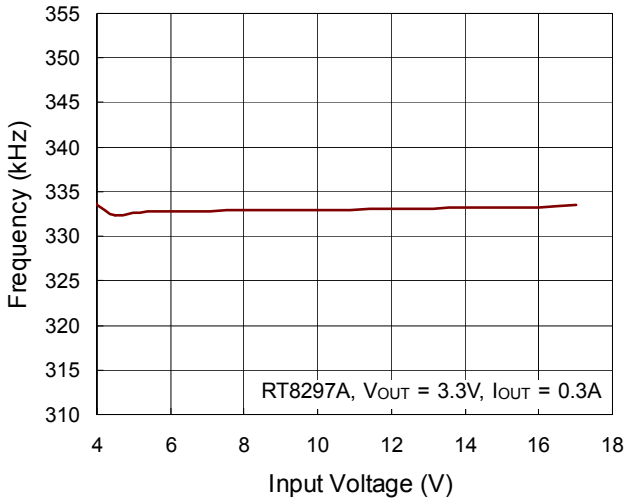

Frequency vs. Input Voltage

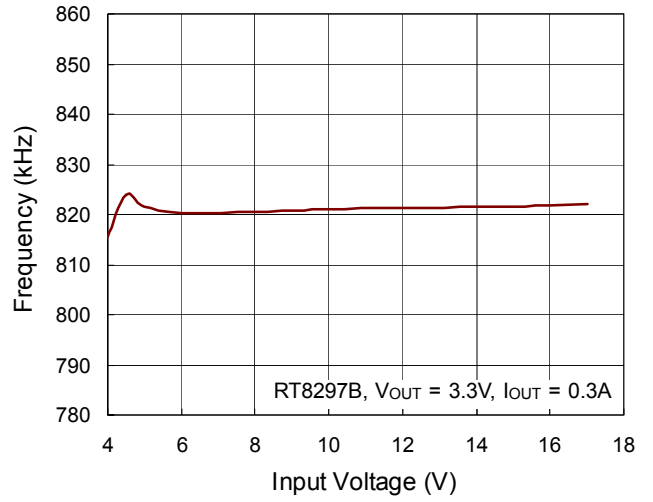

Frequency vs. Temperature

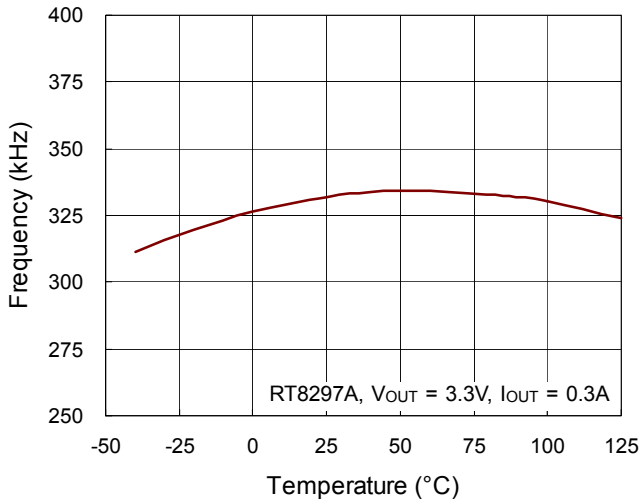

Frequency vs. Temperature

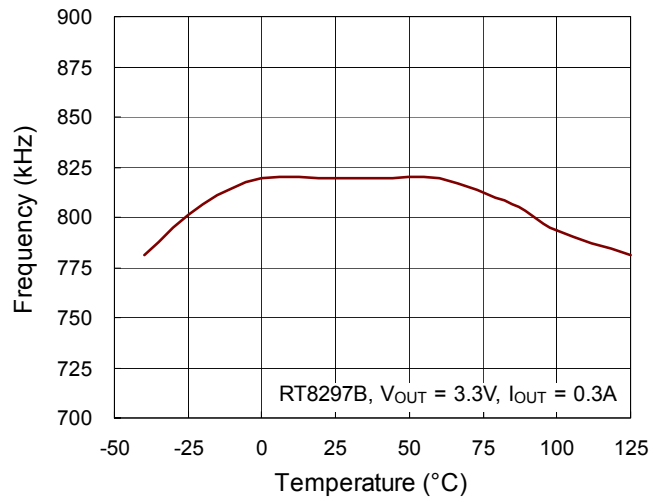

Quiescent Current vs. Input Voltage

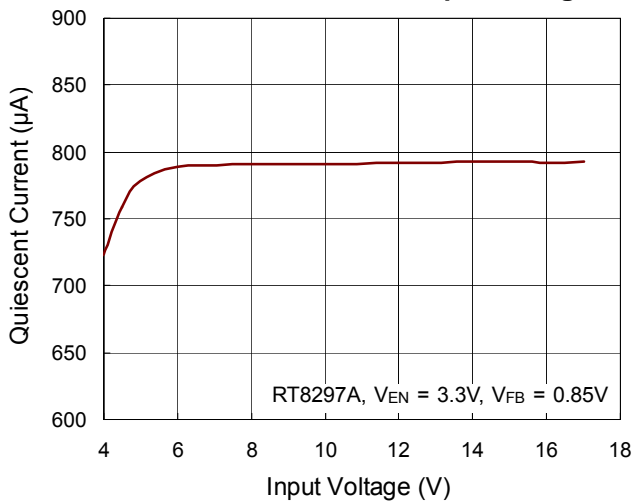

Quiescent Current vs. Input Voltage

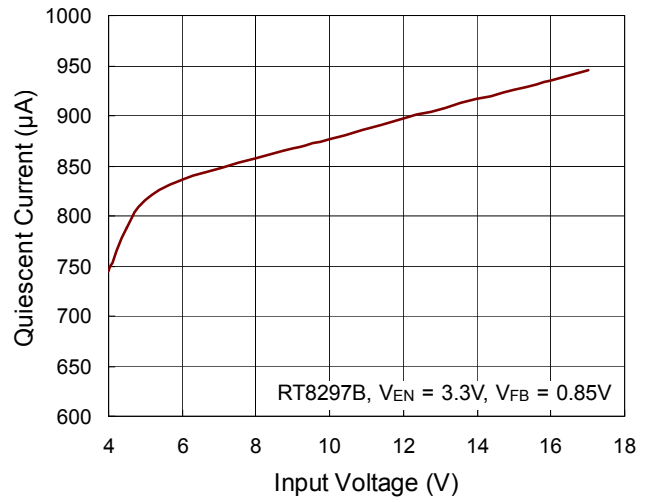

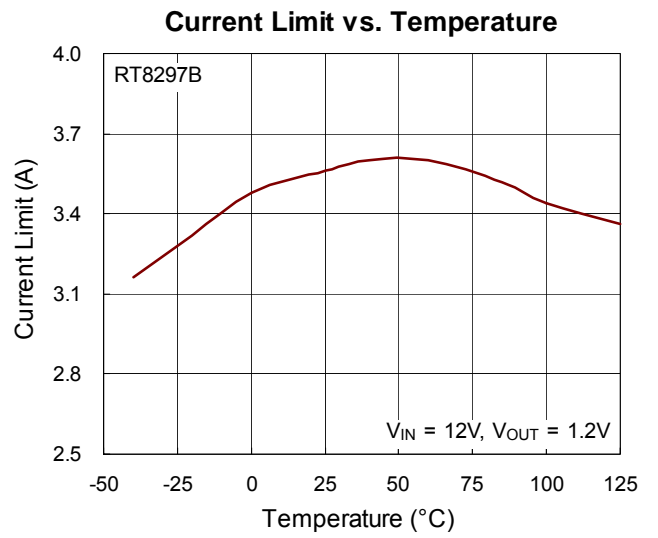
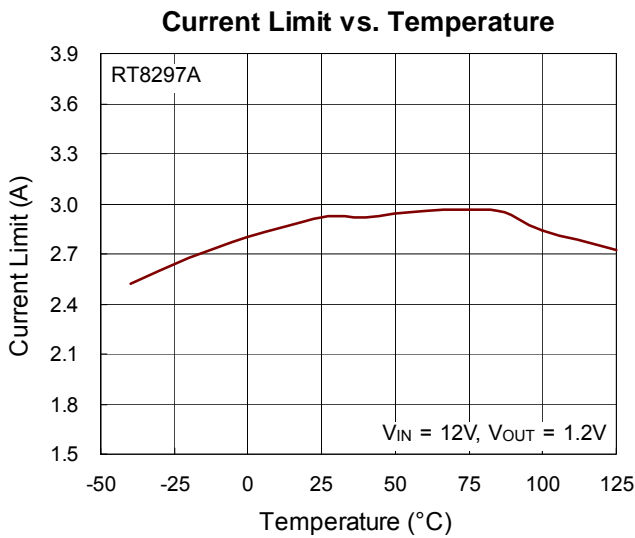
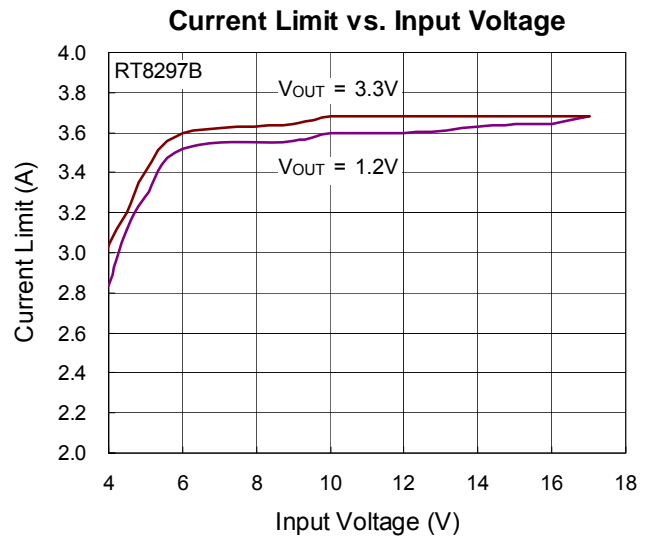
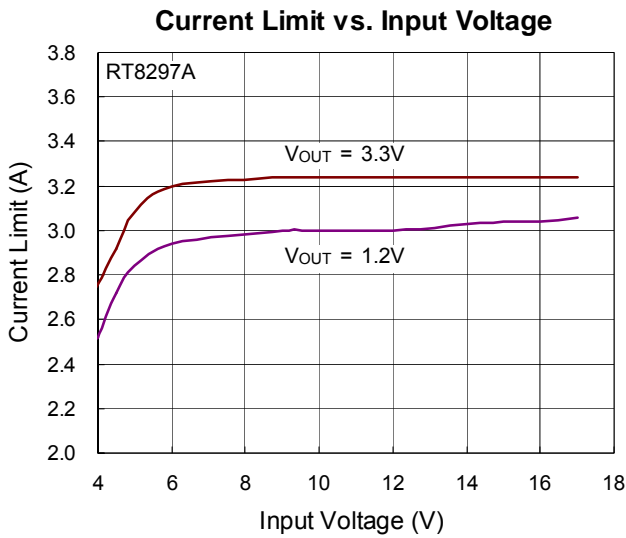
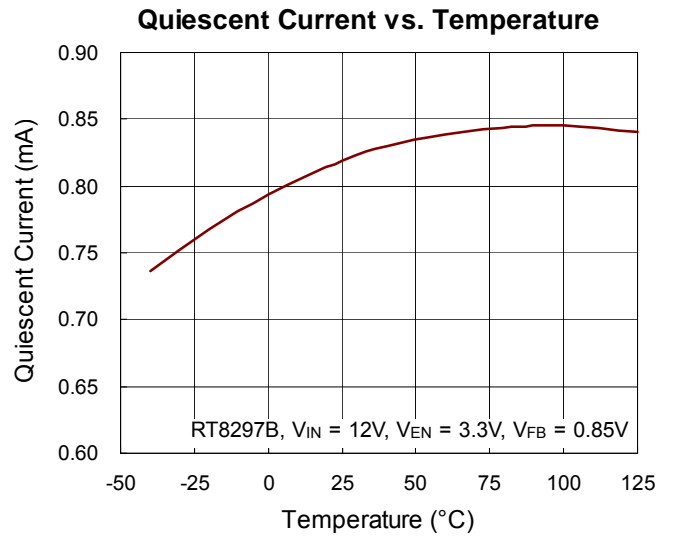
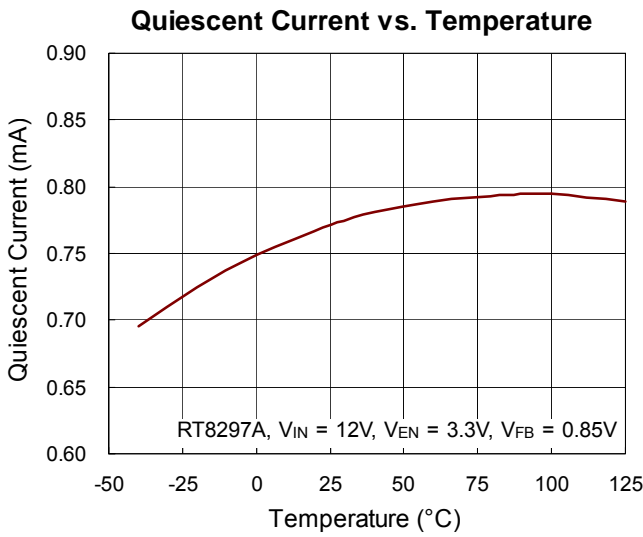

Load Transient Response

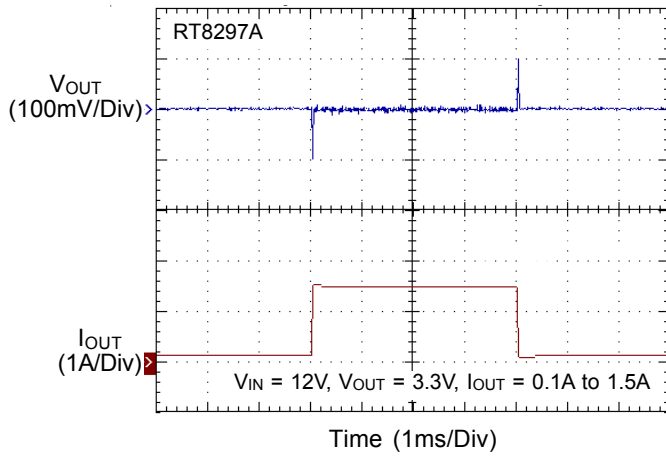

Load Transient Response

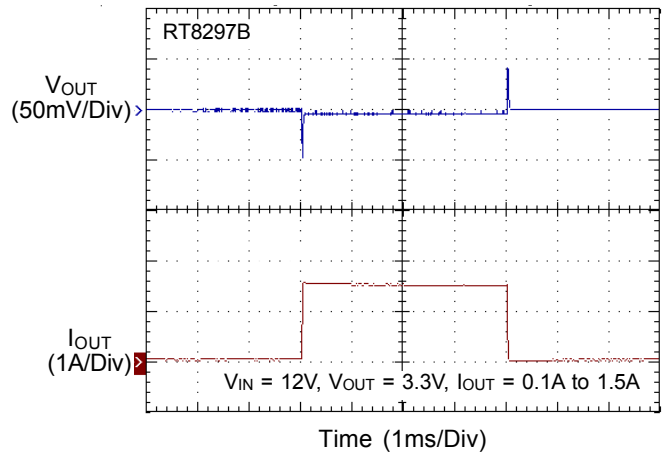

Switching

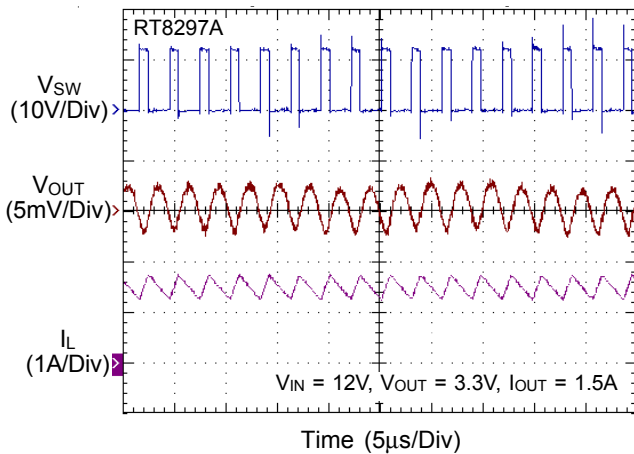

Switching

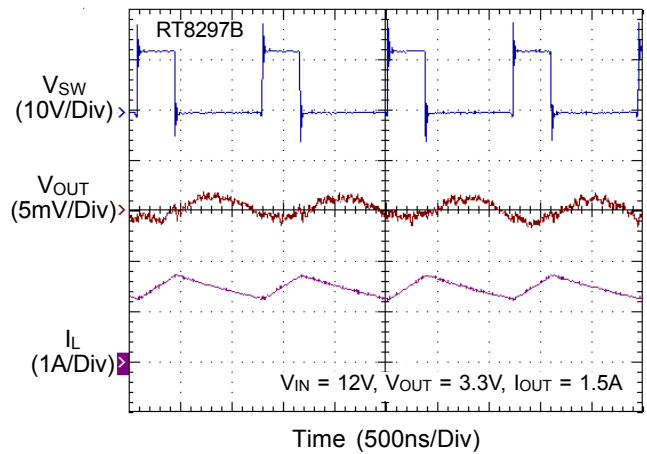

Power On from EN

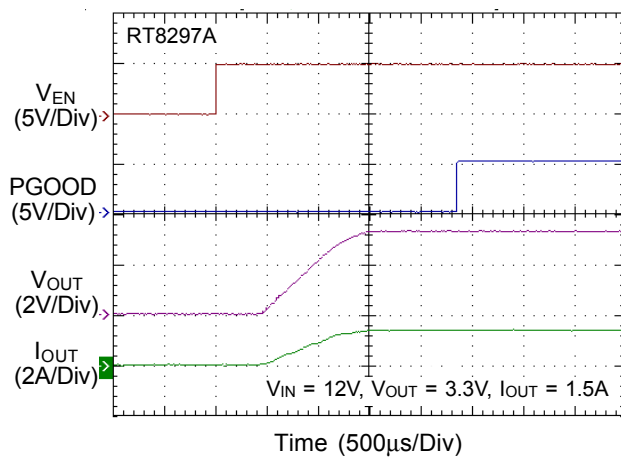

Power On from EN

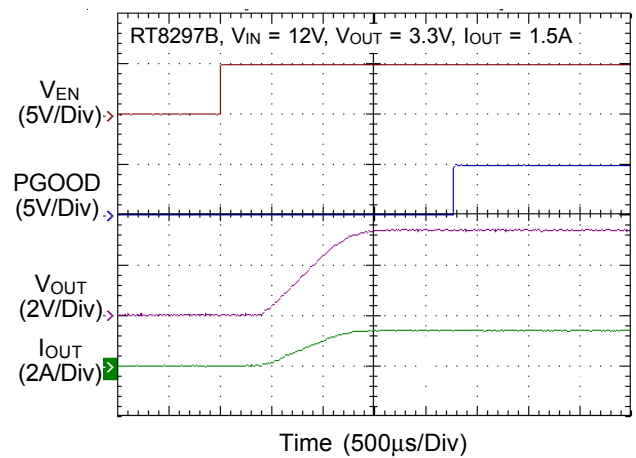

Power Off from EN

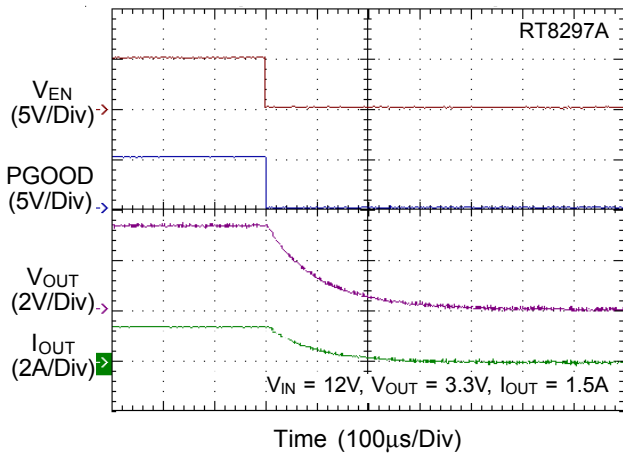

Power Off from EN

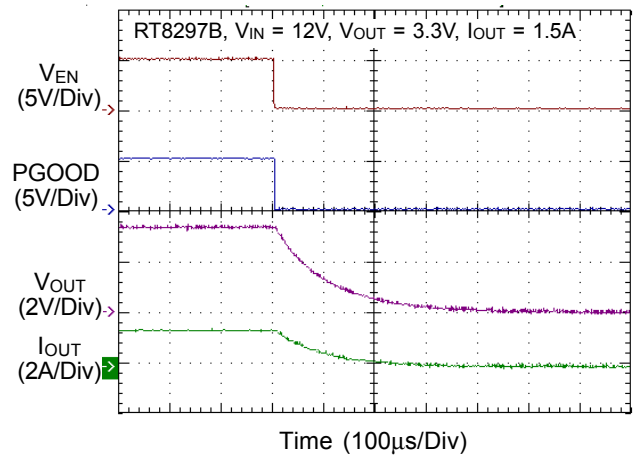

Application Information

The RT8297A/B is a synchronous high voltage buck converter that can support the input voltage range from 4V to 17V and the output current can be up to 1.5A.

Output Voltage Setting

The resistive divider allows the FB pin to sense the output voltage as shown in Figure 1.

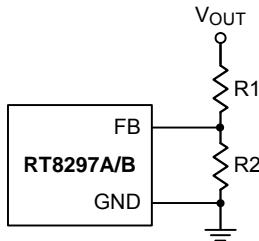

Figure 1. Output Voltage Setting

The output voltage is set by an external resistive divider according to the following equation :

$$V_{OUT} = V_{REF} \left(1 + \frac{R1}{R2} \right)$$

Where V_{REF} is the feedback reference voltage (0.8V typ.).

External Bootstrap Diode

Connect a 10nF low ESR ceramic capacitor between the BOOT pin and SW pin. This capacitor provides the gate driver voltage for the high side MOSFET. It is recommended to add an external bootstrap diode between an external 5V and the BOOT pin for efficiency improvement when input voltage is lower than 5.5V or duty ratio is higher than 65%. The bootstrap diode can be a low cost one such as 1N4148 or BAT54. The external 5V can be a 5V fixed input from system or a 5V output of the RT8297A/B. Note that the external boot voltage must be lower than 5.5V

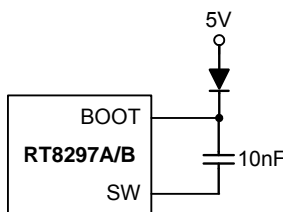

Figure 2. External Bootstrap Diode

Thermal Shutdown

Thermal shutdown is implemented to prevent the chip from operating at excessively high temperatures. When the junction temperature is higher than 150°C, the whole chip is shutdown. The chip is automatically re-enable when the junction temperature cools down by approximately 15 degrees.

Over Voltage Protection (OVP)

The RT8297A/B provides Over Voltage Protection function when output voltage over 125%. The internal MOS will be turned off. The control will return to normal operation if over voltage condition is removed.

Under Voltage Protection (UVP)

For the RT8297A/B, it provides Hiccup Mode Under Voltage Protection (UVP). When the FB voltage drops below 50% of the feedback reference voltage, the UVP function will be triggered and the RT8297A/B will shut down for a period of time and then recover automatically. The Hiccup Mode UVP can reduce input current in short-circuit conditions.

Inductor Selection

The inductor value and operating frequency determine the ripple current according to a specific input and output voltage. The ripple current ΔI_L increases with higher V_{IN} and decreases with higher inductance.

$$\Delta I_L = \left[\frac{V_{OUT}}{f \times L} \right] \left[1 - \frac{V_{OUT}}{V_{IN}} \right]$$

Having a lower ripple current reduces not only the ESR losses in the output capacitors but also the output voltage ripple. High frequency with small ripple current can achieve highest efficiency operation. However, it requires a large inductor to achieve this goal. For the ripple current selection, the value of $\Delta I_L = 0.2(I_{MAX})$ will be a reasonable starting point. The largest ripple current occurs at the highest V_{IN} . To guarantee that the ripple current stays below the specified maximum, the inductor value should be chosen according to the following equation :

$$L = \left[\frac{V_{OUT}}{f \times \Delta I_L(MAX)} \right] \left[1 - \frac{V_{OUT}}{V_{IN(MAX)}} \right]$$

Table 2. Suggested Inductors for Typical Application Circuit

Component Supplier	Series	Dimensions (mm)
TDK	VLF10045	10 x 9.7 x 4.5
TDK	SLF12565	12.5 x 12.5 x 6.5
TAIYO YUDEN	NR8040	8 x 8 x 4

C_{IN} and C_{OUT} Selection

The input capacitance, C_{IN}, is needed to filter the trapezoidal current at the source of the high side MOSFET. To prevent large ripple current, a low ESR input capacitor sized for the maximum RMS current should be used. The RMS current is given by :

$$I_{RMS} = I_{OUT(MAX)} \frac{V_{OUT}}{V_{IN}} \sqrt{\frac{V_{IN}}{V_{OUT}} - 1}$$

This formula has a maximum at V_{IN} = 2V_{OUT}, where I_{RMS} = I_{OUT}/2. This simple worst-case condition is commonly used for design because even significant deviations do not offer much relief. Choose a capacitor rated at a higher temperature than required. Several capacitors may also be paralleled to meet size or height requirements in the design. For the input capacitor, a 10µF low ESR ceramic capacitor is recommended. For the recommended capacitor, please refer to table 3 for more detail. The selection of C_{OUT} is determined by the required ESR to minimize voltage ripple. Moreover, the amount of bulk capacitance is also a key for C_{OUT} selection to ensure that the control loop is stable. Loop stability can be checked by viewing the load transient response as described in a later section. The output ripple, ΔV_{OUT}, is determined by :

$$\Delta V_{OUT} \leq \Delta I_L \left[ESR + \frac{1}{8fC_{OUT}} \right]$$

The output ripple will be highest at the maximum input voltage since ΔI_L increases with input voltage. Multiple capacitors placed in parallel may be needed to meet the ESR and RMS current handling requirement. Dry tantalum, special polymer, aluminum electrolytic and ceramic capacitors are all available in surface mount packages. Special polymer capacitors offer very low ESR value. However, it provides lower capacitance density than other

types. Although Tantalum capacitors have the highest capacitance density, it is important to only use types that pass the surge test for use in switching power supplies. Aluminum electrolytic capacitors have significantly higher ESR. However, it can be used in cost-sensitive applications for ripple current rating and long term reliability considerations. Ceramic capacitors have excellent low ESR characteristics but can have a high voltage coefficient and audible piezoelectric effects. The high Q of ceramic capacitors with trace inductance can also lead to significant ringing.

Higher values, lower cost ceramic capacitors are now becoming available in smaller case sizes. Their high ripple current, high voltage rating and low ESR make them ideal for switching regulator applications. However, care must be taken when these capacitors are used at input and output. When a ceramic capacitor is used at the input and the power is supplied by a wall adapter through long wires, a load step at the output can induce ringing at the input, V_{IN}. At best, this ringing can couple to the output and be mistaken as loop instability. At worst, a sudden inrush of current through the long wires can potentially cause a voltage spike at V_{IN} large enough to damage the part.

Checking Transient Response

The regulator loop response can be checked by looking at the load transient response. Switching regulators take several cycles to respond to a step in load current. When a load step occurs, V_{OUT} immediately shifts by an amount equal to ΔI_{LOAD} (ESR) also begins to charge or discharge C_{OUT} generating a feedback error signal for the regulator to return V_{OUT} to its steady-state value. During this recovery time, V_{OUT} can be monitored for overshoot or ringing that would indicate a stability problem.

Thermal Considerations

For continuous operation, do not exceed absolute maximum junction temperature. The maximum power dissipation depends on the thermal resistance of the IC package, PCB layout, rate of surrounding airflow, and difference between junction and ambient temperature. The maximum power dissipation can be calculated by the following formula :

$$P_{D(MAX)} = (T_{J(MAX)} - T_A) / \theta_{JA}$$

where $T_{J(MAX)}$ is the maximum junction temperature, T_A is the ambient temperature, and θ_{JA} is the junction to ambient thermal resistance.

For recommended operating condition specifications, the maximum junction temperature is 125°C. The junction to ambient thermal resistance, θ_{JA} , is layout dependent. For WDFN-8L 2x2 package, the thermal resistance, θ_{JA} , is 120°C/W on a standard JEDEC 51-7 four-layer thermal test board. The maximum power dissipation at $T_A = 25^\circ\text{C}$ can be calculated by the following formula :

$$P_{D(MAX)} = (125^\circ\text{C} - 25^\circ\text{C}) / (120^\circ\text{C/W}) = 0.833\text{W for WDFN-8L 2x2 package}$$

The maximum power dissipation depends on the operating ambient temperature for fixed $T_{J(MAX)}$ and thermal resistance, θ_{JA} . The derating curve in Figure 3 allows the designer to see the effect of rising ambient temperature on the maximum power dissipation.

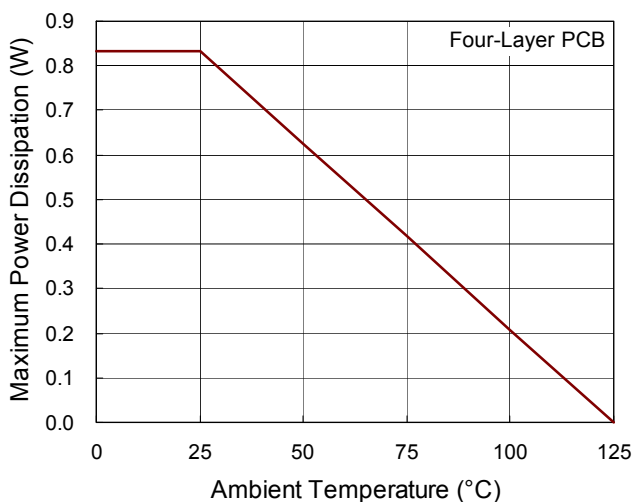

Figure 3. Derating Curve of Maximum Power Dissipation

Layout Consideration

Follow the PCB layout guidelines for optimal performance of the RT8297A/B

- ▶ Keep the traces of the main current paths as short and wide as possible.
- ▶ Put the input capacitor as close as possible to the device pins (VIN and GND).
- ▶ SW node is with high frequency voltage swing and should be kept at small area. Keep sensitive components away from the SW node to prevent stray capacitive noise pickup.
- ▶ Place the feedback components to the FB pin as close as possible.
- ▶ The GND and Exposed Pad should be connected to a strong ground plane for heat sinking and noise protection.

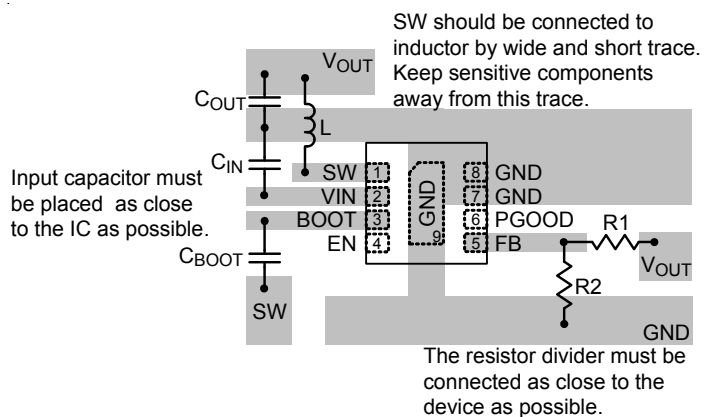
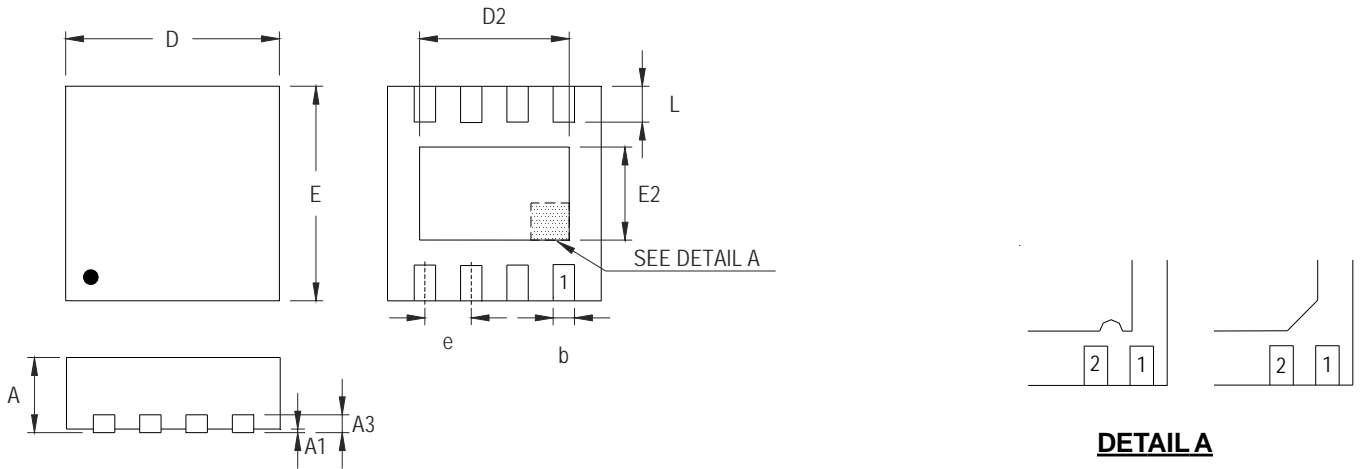

Figure 4. PCB Layout Guide

Table 3. Suggested Capacitors for C_{IN} and C_{OUT}

Location	Component Supplier	Part No.	Capacitance (μF)	Case Size
C _{IN}	MURATA	GRM31CR61E106K	10	1206
C _{IN}	TDK	C3225X5R1E106K	10	1206
C _{IN}	TAIYO YUDEN	TMK316BJ106ML	10	1206
C _{OUT}	MURATA	GRM32ER61E226M	22	1210
C _{OUT}	MURATA	GRM21BR60J226M	22	0805
C _{OUT}	TDK	C3225X5R0J226M	22	1210
C _{OUT}	TAIYO YUDEN	EMK325BJ226MM	22	1210

Outline Dimension



DETAIL A
Pin #1 ID and Tie Bar Mark Options

Note : The configuration of the Pin #1 identifier is optional, but must be located within the zone indicated.

Symbol	Dimensions In Millimeters		Dimensions In Inches	
	Min	Max	Min	Max
A	0.700	0.800	0.028	0.031
A1	0.000	0.050	0.000	0.002
A3	0.175	0.250	0.007	0.010
b	0.200	0.300	0.008	0.012
D	1.950	2.050	0.077	0.081
D2	1.000	1.250	0.039	0.049
E	1.950	2.050	0.077	0.081
E2	0.400	0.650	0.016	0.026
e	0.500		0.020	
L	0.300	0.400	0.012	0.016

W-Type 8L DFN 2x2 Package

Richtek Technology Corporation

14F, No. 8, Tai Yuen 1st Street, Chupei City
Hsinchu, Taiwan, R.O.C.
Tel: (8863)5526789

Richtek products are sold by description only. Customers should obtain the latest relevant information and data sheets before placing orders and should verify that such information is current and complete. Richtek cannot assume responsibility for use of any circuitry other than circuitry entirely embodied in a Richtek product. Information furnished by Richtek is believed to be accurate and reliable. However, no responsibility is assumed by Richtek or its subsidiaries for its use; nor for any infringements of patents or other rights of third parties which may result from its use. No license is granted by implication or otherwise under any patent or patent rights of Richtek or its subsidiaries.