

3A, Ultra-Low Dropout Voltage Regulator

General Description

The RT9059B is a high performance positive voltage regulator designed for use in applications requiring very low input voltage and very low dropout voltage at up to 3A. It operates with a VIN as low as 1V and VDD voltage 3V with programmable output voltage as low as 0.8V. The RT9059B features ultra low dropout, ideal for applications where VOUT is very close to VIN. Additionally, it has an enable pin to further reduce power dissipation while shutdown. The RT9059B provides excellent regulation over variations in line, load and temperature. The RT9059B provides a power good signal to indicate if the voltage level of VO reaches 90% of its rating value.

Ordering Information

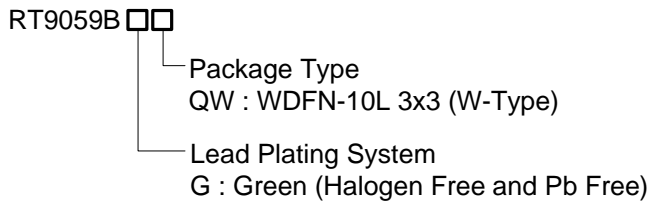

Note :

Richtek products are :

- ▶ RoHS compliant and compatible with the current requirements of IPC/JEDEC J-STD-020.
- ▶ Suitable for use in SnPb or Pb-free soldering processes.

Marking Information

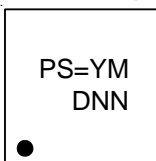

PS= : Product Code
YMDNN : Date Code

Features

- Output Current up to 3A
- High Accuracy ADJ Voltage 1%
- Dropout Voltage 350mV @ 3A Typically
- VOUT Power Good Signal
- VOUT Pull Low Resistance when Disable
- Current Limiting Protection
- Thermal Shutdown Protection
- RoHS Compliant and Halogen Free

Applications

- Notebook PC Applications
- Motherboard Applications

Pin Configuration

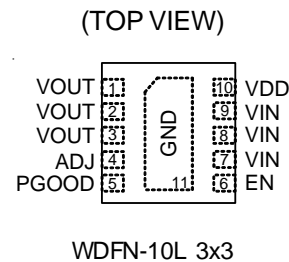

Typical Application Circuit

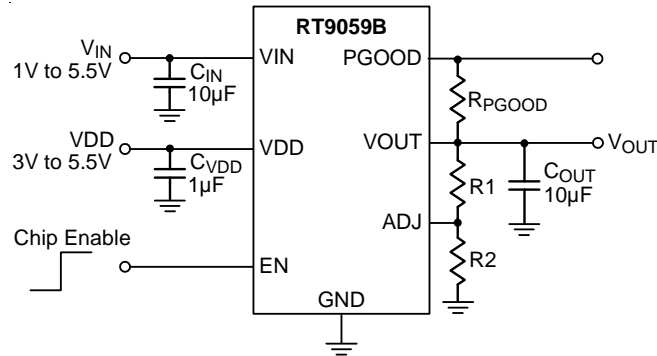

$$V_{OUT} = 0.8 \times (R1+R2)/R2$$

Functional Pin Description

Pin No.	Pin Name	Pin Function
1, 2, 3	VOUT	Output voltage.
4	ADJ	Output voltage setting. $V_{OUT} = V_{REF} \times (R1 + R2) / R2$.
5	PGOOD	Power good open drain output.
6	EN	Enable control input.
7, 8, 9	VIN	Supply input voltage.
10	VDD	Supply voltage of control circuit.
11 (Exposed Pad)	GND	Ground. The exposed pad must be soldered to a large PCB and connected to GND for maximum power dissipation.

Functional Block Diagram

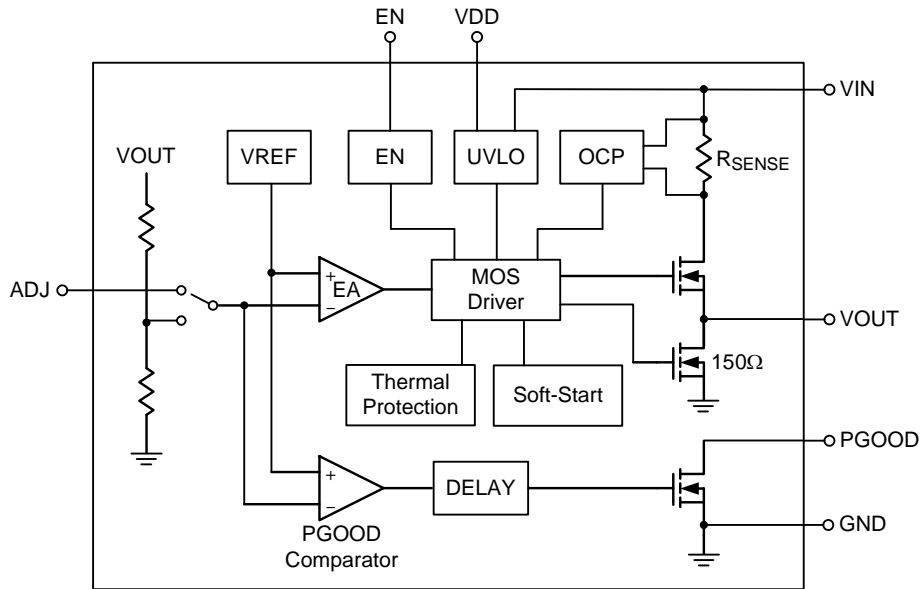

Operation

The RT9059B is a high performance positive voltage regulator designed for use in very low input voltage and very low dropout voltage with high output current up to 3A.

Output Transistor

The RT9059B includes a built-in low dropout N-MOSFET output transistor for low input voltage and high output current applications.

Error Amplifier

The Error Amplifier compares output feedback voltage from an internal feedback voltage divider or from ADJ pin to an internal reference voltage and controls the N-MOSFET gate voltage to maintain output voltage regulation.

Soft-Start

The RT9059B provides soft-start function to prevent large in-rush current during power on period.

Current Limit and Over-Temperature Protection

The RT9059B provides a current limit function to prevent damage during output over-load or short-circuit conditions. The output current is detected by an internal sensing transistor.

The RT9059B also equips Over-Temperature Protection (OTP) function. When the internal junction temperature exceeds 160°C, OTP function will turn off the N-MOSFET. Once the junction temperature cools down below 90°C, the RT9059B will resume operation automatically.

Absolute Maximum Ratings (Note 1)

- Supply Input Voltage, VIN to GND
 - DC----- -0.3V to 6V
 - < 10ms----- -0.3V to 7V
- Control Voltage, VDD to GND
 - DC----- -0.3V to 6V
 - < 10ms----- -0.3V to 7V
- Output Voltage, VOUT ----- -0.3V to 6V
- Chip Enable Voltage, EN ----- -0.3V to 6V
- Adjust Voltage, ADJ ----- -0.3V to 6V
- Power Good Voltage, VPGOOD ----- -0.3V to 6V
- Power Dissipation, PD @ TA = 25°C
 - WDFN-10L 3x3----- 3.04W
- Package Thermal Resistance (Note 2)
 - WDFN-10L 3x3, θJA ----- 32.8°C/W
 - WDFN-10L 3x3, θJC ----- 5.9°C/W
- Junction Temperature ----- 150°C
- Lead Temperature (Soldering, 10 sec.)----- 260°C
- Storage Temperature Range ----- -65°C to 150°C
- ESD Susceptibility (Note 3)
 - HBM (Human Body Model)----- 2kV

Recommended Operating Conditions (Note 4)

- Supply Input Voltage, VIN ----- 1V to 5.5V
- Control Voltage, VDD (VDD > VOUT + 1.5V) ----- 3V to 5.5V
- Junction Temperature Range ----- -40°C to 125°C
- Ambient Temperature Range ----- -40°C to 85°C

Electrical Characteristics

(VDD = 5V, CIN = COUT = 10μF, CVDD = 1μF, TA = 25°C, unless otherwise specified)

Parameter	Symbol	Test Conditions	Min	Typ	Max	Unit
VDD Operation Range	VDD		3	--	5.5	V
VDD POR Threshold	VPOR_VDD	VDD rising	2.4	2.7	3	V
VDD POR Falling Hysteresis	ΔVPOR_VDD	VDD falling	0.15	0.2	--	V
Input Voltage Range	VIN		1	--	5.5	V
VIN POR Threshold	VPOR_VIN	VIN rising	0.7	0.8	0.9	V
VIN POR Falling Hysteresis	ΔVPOR_VIN	VIN falling	0.15	0.2	0.25	V
Quiescent Current	IQ	EN on, no load	--	0.6	1.2	mA
Reference Voltage	VREF		0.794	0.8	0.806	V
Output Voltage Accuracy			-1	--	1	%

Parameter	Symbol	Test Conditions	Min	Typ	Max	Unit
VOUT Load Regulation	ΔV_{LOAD}	$I_{OUT} = 1mA \text{ to } 3A,$ $V_{IN} = V_{OUT} + 1V$	--	0.5	1	%
OUT Line Regulation	ΔV_{LINE}	$V_{DD} = 3.6V \text{ to } 5.5V,$ $V_{IN} = V_{OUT} + 1V \text{ to } 5V, I_{OUT} = 1mA$	--	0.2	0.6	%
Dropout Voltage	V_{DROP}	$I_{OUT} = 2A$	--	250	350	mV
		$I_{OUT} = 3A$	--	350	450	
Current Limit	I_{LIM}	$V_{IN} = 3.6V$	3.1	3.6	4.2	A
Short Circuit Current	I_{SC}	$V_{OUT} < 0.2V$	1	1.4	1.8	A
VOUT Pull Low Resistance	R_{PULL}	$V_{EN} = 0V$	--	150	--	Ω
Thermal Shutdown Temperature	T_{SD}		--	160	--	$^{\circ}C$
Thermal Shutdown Recovery Temperature	T_{SDR}		--	90	--	$^{\circ}C$
PGOOD Rising Threshold	V_{TH_PGOOD}	V_{OUT} rising	--	90	--	%
PGOOD Hysteresis	ΔV_{TH_PGOOD}	V_{OUT} falling	--	10	--	%
PGOOD Delay Time			--	1	1.5	ms
PGOOD Sink Capability	V_{PGOOD}	$I_{SINK} = 10mA$	--	0.2	0.4	V
EN Input Voltage	Logic-High	V_{IH}	1.2	--	--	V
	Logic-Low	V_{IL}	--	--	0.4	
EN Delay Time			0.3	0.85	1.4	ms
EN Pin Bias Current	I_{EN}	$V_{EN} = 5V$	--	12	--	μA
VDD Pin Shutdown Current	I_{SHDN_VDD}	$V_{EN} = 0V$	--	--	1	μA
VIN Pin Shutdown Current	I_{SHDN_VIN}	$V_{EN} = 0V, V_{IN} = 5V$	--	--	1	μA
Inrush Current	I_{INRUSH}	$V_{OUT} = 1.8V, C_{OUT} = 10\mu F,$ $I_{LOAD} = 1A$	--	0.5	--	A
Soft-Start Time	tss		1.9	2.8	3.75	ms

Note 1. Stresses beyond those listed under "Absolute Maximum Ratings" may cause permanent damage to the device. These are stress ratings only, and functional operation of the device at these or any other conditions beyond those indicated in the operational sections of the specifications is not implied. Exposure to absolute maximum rating conditions may affect device reliability.

Note 2. θ_{JA} is measured under natural convection (still air) at $T_A = 25^{\circ}C$ with the component mounted on a high effective-thermal-conductivity four-layer test board on a JEDEC 51-7 thermal measurement standard. θ_{JC} is measured at the exposed pad of the package.

Note 3. Devices are ESD sensitive. Handling precaution recommended.

Note 4. The device is not guaranteed to function outside its operating conditions.

Typical Operating Characteristics

Quiescent Current vs. Temperature

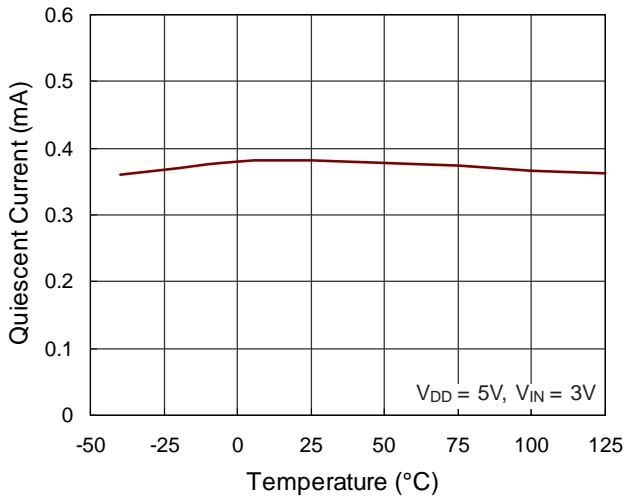

Current Limit vs. Temperature

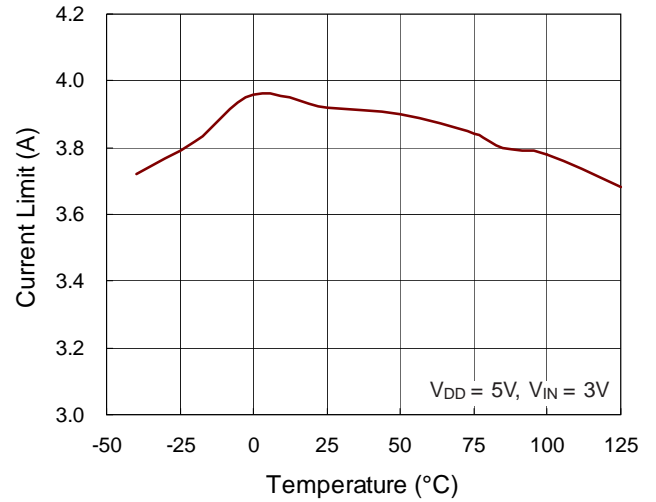

Dropout Voltage vs. Temperature

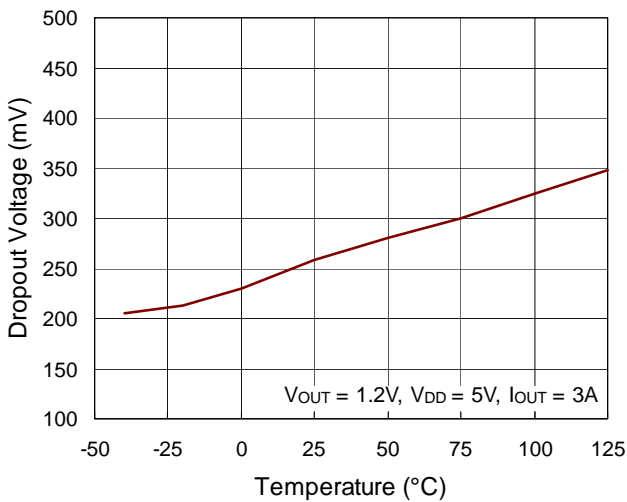

VREF Voltage vs. Temperature

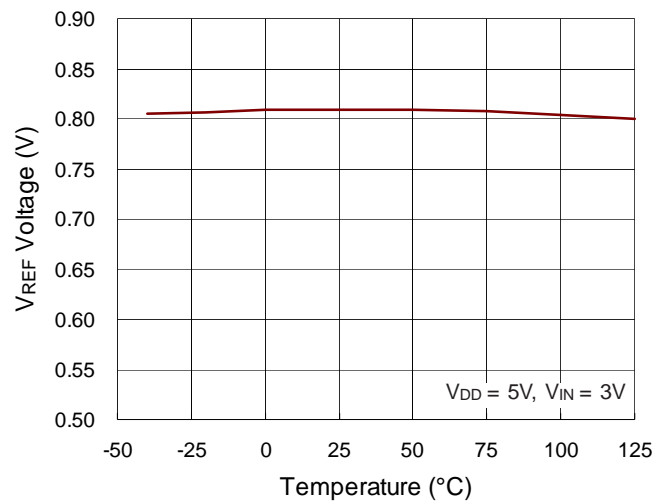

PGOOD Delay Time vs. Temperature

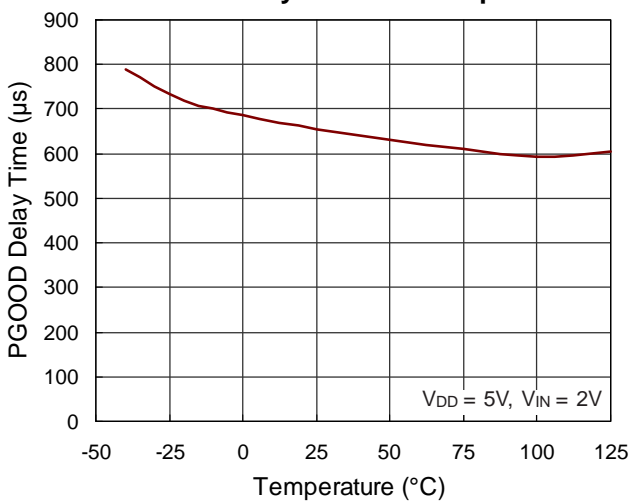

EN Threshold Voltage vs. Temperature

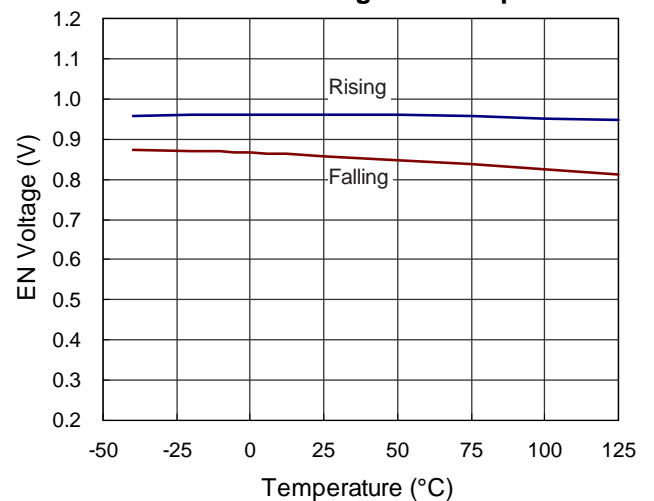

VDD POR Threshold Voltage vs. Temperature

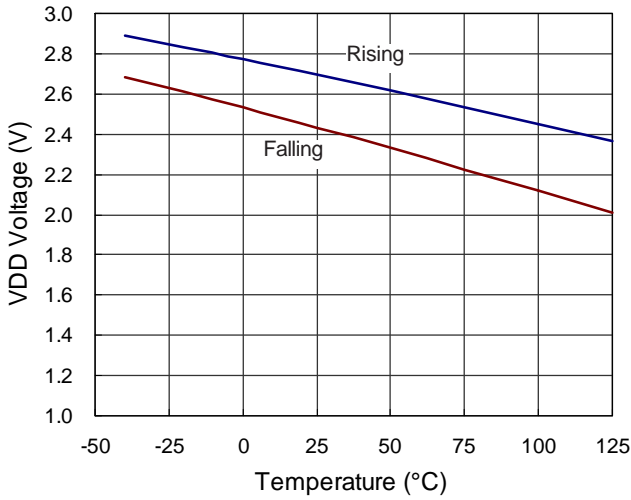

Dropout Voltage vs. Load Current

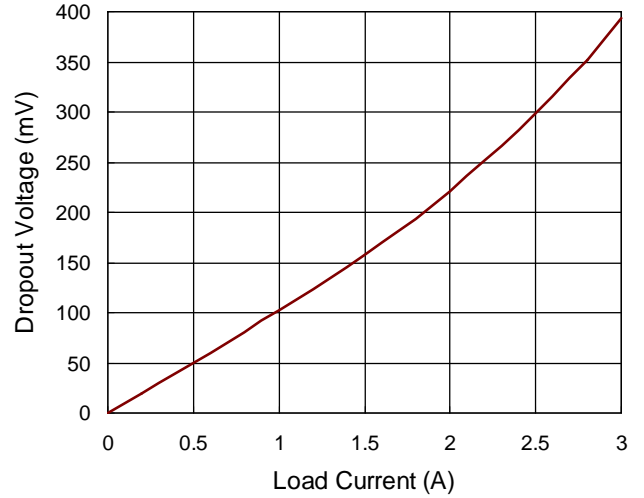

PSRR vs. Frequency

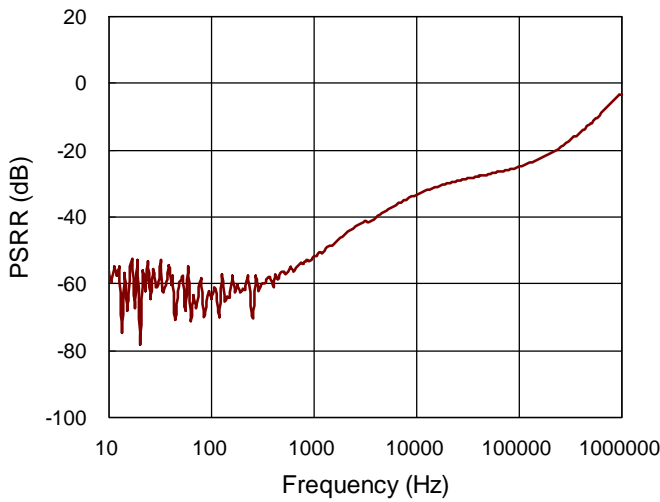

Load Transient Response

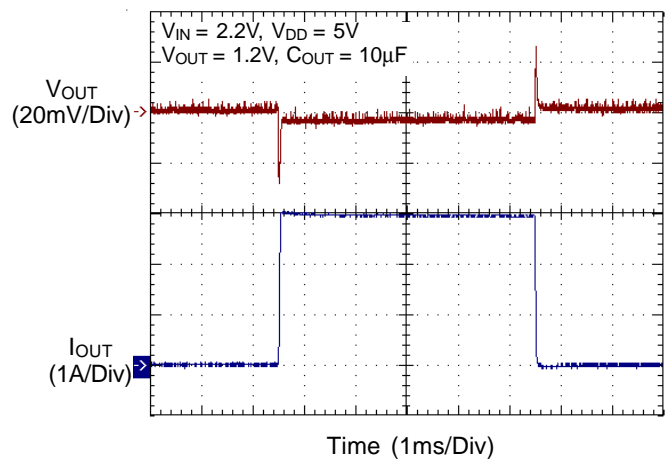

VIN Line Transient Response

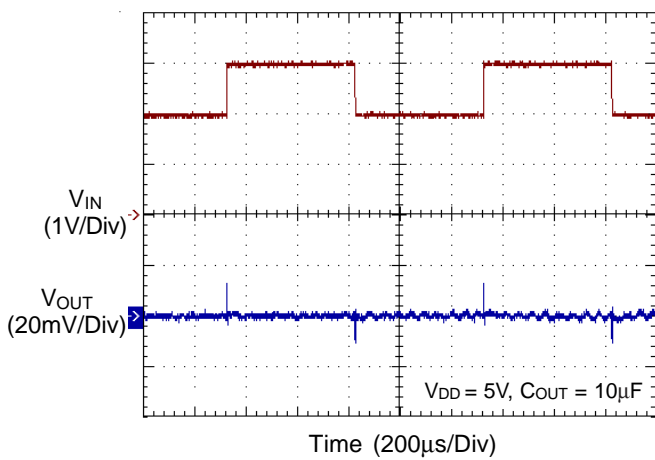

VDD Line Transient Response

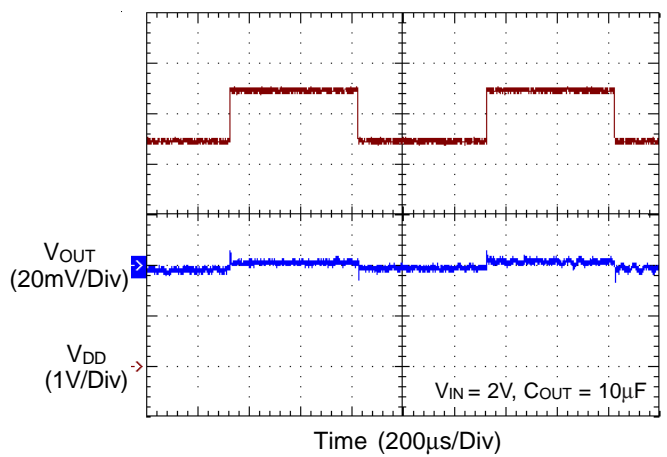

Start Up from V_{DD}

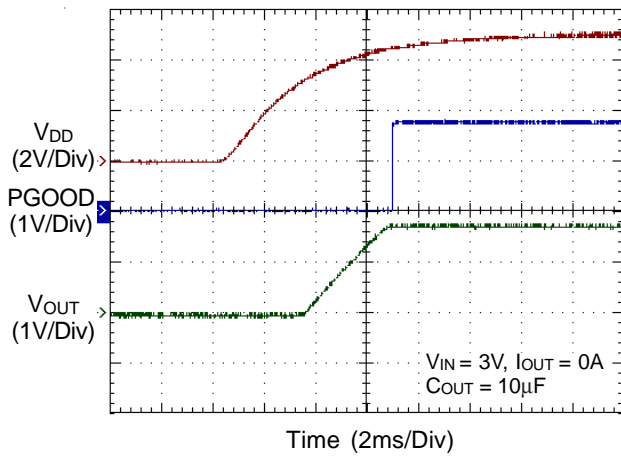

Start Up from V_{IN}

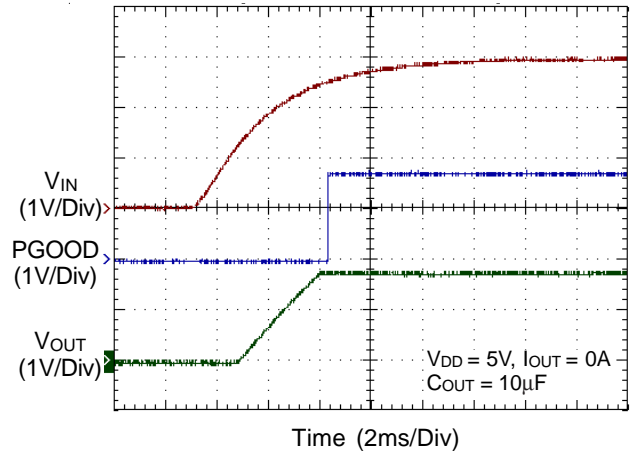

Start Up from Enable and PGOOD Delay

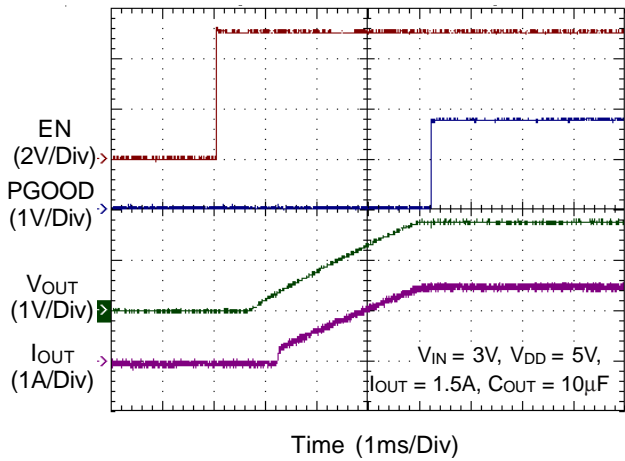

Applications Information

Adjustable Mode Operation

The output voltage of the RT9059B is adjustable from 0.8V to VIN by external voltage divider resistors as shown in Typical Application Circuit. The value of resistors R1 and R2 should be more than 10kΩ to reduce the power loss. The output voltage can be calculated by the following equation :

$$V_{OUT} = V_{REF} \times \left(1 + \frac{R1}{R2}\right)$$

where VREF is the reference voltage (0.8V typical).

Enable

The RT9059B goes into shutdown mode when the EN pin is in the logic low condition. During this condition, the pass transistor, error amplifier, and band gap are turned off, reducing the supply current to 1μA typical. The RT9059B goes into operation mode when the EN pin is in the logic high condition. If the EN pin is floating, please notice the RT9059B internal initial logic level. For the RT9059B, the EN pin function pulls low level internally. So the regulator will be turned off when EN pin is floating.

Input Capacitor

Good bypassing is recommended from input to ground to improve AC performance. A 10μF input capacitor or greater located as close as possible to the IC is recommended.

Output Capacitor

The RT9059B is designed specifically to work with low ESR ceramic output capacitor in space-saving and performance consideration. Using a ceramic capacitor which value is at least 10μF on the RT9059B output ensures stability. Output capacitor of larger capacitance can reduce noise and improve load transient response, stability, and PSRR. The output capacitor should be located not more than 0.5 inch from the VOUT pin of the RT9059B and returned to a clean analog ground.

Current Limit

The RT9059B contains an independent current limit and the short circuit current protection to prevent unexpected applications. The current limit monitors and controls the pass transistor's gate voltage, minimum limiting the output current to 3.1A typical. When the output voltage is less than 0.2V, the short circuit current protection starts the current fold back function and maintains the loading current at maximum 1.8A. The output can be shorted to ground indefinitely without damaging the part.

Power Good

The power good function is an open-drain output. Connect 100kΩ pull up resistor to VOUT to obtain an output voltage. The PGOOD pin will output high immediately after the output voltage arrives 90% of normal output voltage.

Thermal Shutdown Protection

Thermal protection limits power dissipation to prevent IC over temperature in the RT9059B. When the operation junction temperature exceeds 160°C, the over temperature protection circuit starts the thermal shutdown function and turns the pass transistor off. The pass transistor turns on again after the junction temperature cools by 70°C.

Thermal Considerations

The junction temperature should never exceed the absolute maximum junction temperature TJ(MAX), listed under Absolute Maximum Ratings, to avoid permanent damage to the device. The maximum allowable power dissipation depends on the thermal resistance of the IC package, the PCB layout, the rate of surrounding airflow, and the difference between the junction and ambient temperatures. The maximum power dissipation can be calculated using the following formula :

$$P_{D(MAX)} = (T_{J(MAX)} - T_A) / \theta_{JA}$$

where TJ(MAX) is the maximum junction temperature, TA is the ambient temperature, and θJA is the junction-to-ambient thermal resistance.

For continuous operation, the maximum operating junction temperature indicated under Recommended Operating

Conditions is 125°C. The junction-to-ambient thermal resistance, θ_{JA} , is highly package dependent. For a WDFN-10L 3x3 package, the thermal resistance, θ_{JA} , is 32.8°C/W on a standard JEDEC 51-7 high effective-thermal-conductivity four-layer test board. The maximum power dissipation at $T_A = 25^\circ\text{C}$ can be calculated as below :

$$P_{D(\text{MAX})} = (125^\circ\text{C} - 25^\circ\text{C}) / (32.8^\circ\text{C/W}) = 3.04\text{W for a WDFN-10L 3x3 package.}$$

The maximum power dissipation depends on the operating ambient temperature for the fixed $T_{J(\text{MAX})}$ and the thermal resistance, θ_{JA} . The derating curves in Figure 1 allows the designer to see the effect of rising ambient temperature on the maximum power dissipation.

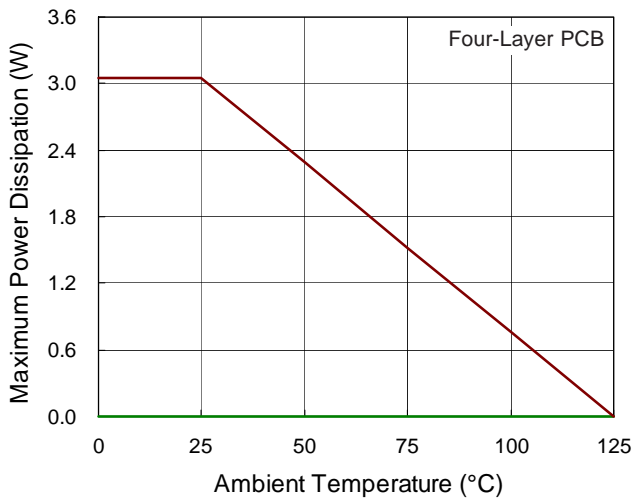
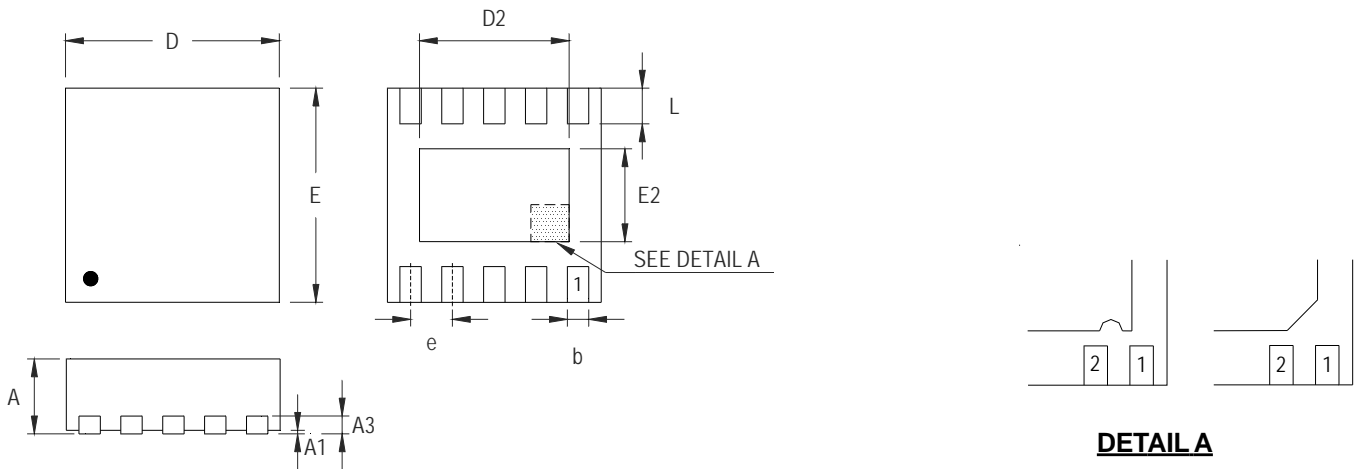

Figure 1. Derating Curve of Maximum Power Dissipation

Outline Dimension



DETAIL A

Pin #1 ID and Tie Bar Mark Options

Note : The configuration of the Pin #1 identifier is optional, but must be located within the zone indicated.

Symbol	Dimensions In Millimeters		Dimensions In Inches	
	Min	Max	Min	Max
A	0.700	0.800	0.028	0.031
A1	0.000	0.050	0.000	0.002
A3	0.175	0.250	0.007	0.010
b	0.180	0.300	0.007	0.012
D	2.950	3.050	0.116	0.120
D2	2.300	2.650	0.091	0.104
E	2.950	3.050	0.116	0.120
E2	1.500	1.750	0.059	0.069
e	0.500		0.020	
L	0.350	0.450	0.014	0.018

W-Type 10L DFN 3x3 Package

Footprint Information

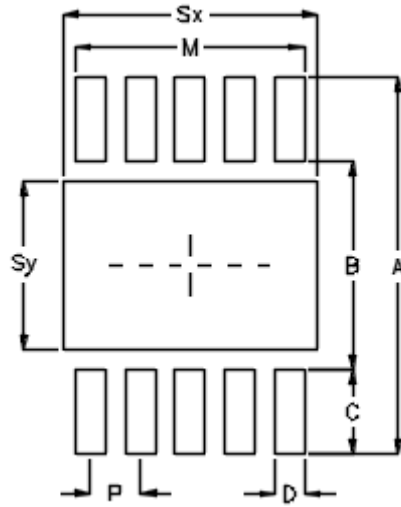

Package	Number of Pin	Footprint Dimension (mm)								Tolerance
		P	A	B	C	D	Sx	Sy	M	
V/W/U/X/ZDFN3*3-10	10	0.50	3.80	2.10	0.85	0.30	2.55	1.70	2.30	±0.05

Richtek Technology Corporation

14F, No. 8, Tai Yuen 1st Street, Chupei City
 Hsinchu, Taiwan, R.O.C.
 Tel: (8863)5526789

Richtek products are sold by description only. Customers should obtain the latest relevant information and data sheets before placing orders and should verify that such information is current and complete. Richtek cannot assume responsibility for use of any circuitry other than circuitry entirely embodied in a Richtek product. Information furnished by Richtek is believed to be accurate and reliable. However, no responsibility is assumed by Richtek or its subsidiaries for its use; nor for any infringements of patents or other rights of third parties which may result from its use. No license is granted by implication or otherwise under any patent or patent rights of Richtek or its subsidiaries.