

2A, Low Input Voltage, Ultra-Low Dropout LDO Regulator with Enable

General Description

The RTQ9091 is a high performance positive voltage regulator designed for use in applications requiring ultra-low input voltage and ultra-low dropout voltage at up to 2 amperes. It operates with an input voltage as low as 1.4V, with output voltage programmable as low as 0.5V. The RTQ9091 features ultra low dropout, ideal for applications where output voltage is very close to input voltage. Additionally, the RTQ9091 has an enable pin to further reduce power dissipation while shutdown. The RTQ9091 provides excellent regulation over variations in line, load and temperature. The RTQ9091 is available in the SOP-8 (Exposed Pad) package. The output voltage can be set by an external divider depending on how the FB pin is configured.

Ordering Information

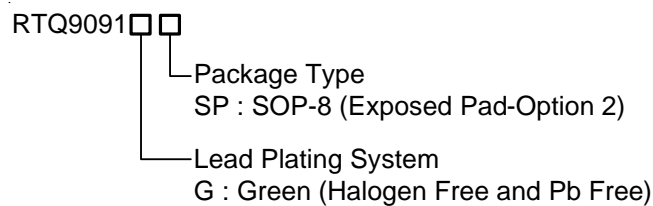

Note :

Richtek products are :

- ▶ RoHS compliant and compatible with the current requirements of IPC/JEDEC J-STD-020.
- ▶ Suitable for use in SnPb or Pb-free soldering processes.

Features

- Input Voltage as Low as 1.4V
- Ultra-Low Dropout Voltage 400mV at 2A
- Over-Current Protection
- Over-Temperature Protection
- 1 μ A Input Current in Shutdown Mode
- Enable Control
- RoHS Compliant and Halogen Free

Applications

- Telecom/Networking Cards
- Motherboards/Peripheral Cards
- Industrial Applications
- Wireless Infrastructure
- Set Top Box
- Medical Equipment
- Notebook Computers
- Battery Powered Systems

Pin Configuration

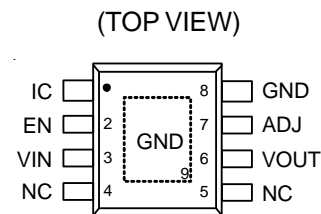

SOP-8 (Exposed Pad)

Simplified Application Circuit

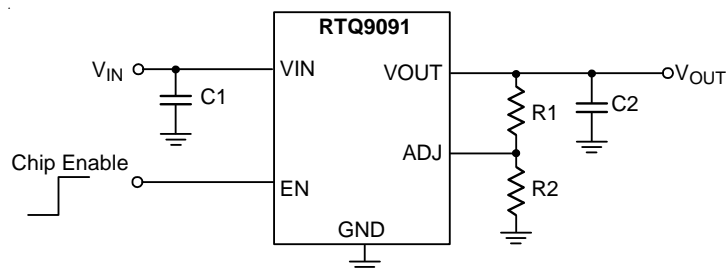

Marking Information

RTQ9091 GSPYMDNN •

RTQ9091GSP : Product Number

YMDNN : Date Code

Functional Pin Description

Pin No.	Pin Name	Pin Function
1	IC	Internal connection. Keep this pin floating for normal operation.
4, 5	NC	No internal connection.
2	EN	Chip enable (Active-High). Pulling this pin below 0.4V to turn the regulator off. The device will be enabled if this pin is left open. Connect to VIN for controlling by VIN.
3	VIN	Power input. For regulation at full load, the input to this pin must be between (V _{OUT} + 0.5V) and 6V. Minimum input voltage is 1.4V. A large bulk capacitance should be placed closely to this pin to ensure that the input supply does not sag below 1.4V. A minimum of 10 μ F ceramic capacitor should be placed directly at this pin.
6	VOUT	Output of the regulator. A minimum of 10 μ F capacitor should be placed directly at this pin.
7	ADJ	Feedback voltage input. If connected to the VOUT pin, the output voltage will be set at 0.5V. If external feedback resistors are used, the output voltage will be determined by the resistor ratio.
8, 9 (Exposed pad)	GND	Ground. The exposed pad must be soldered to a large PCB and connected to GND for maximum power dissipation.

Functional Block Diagram

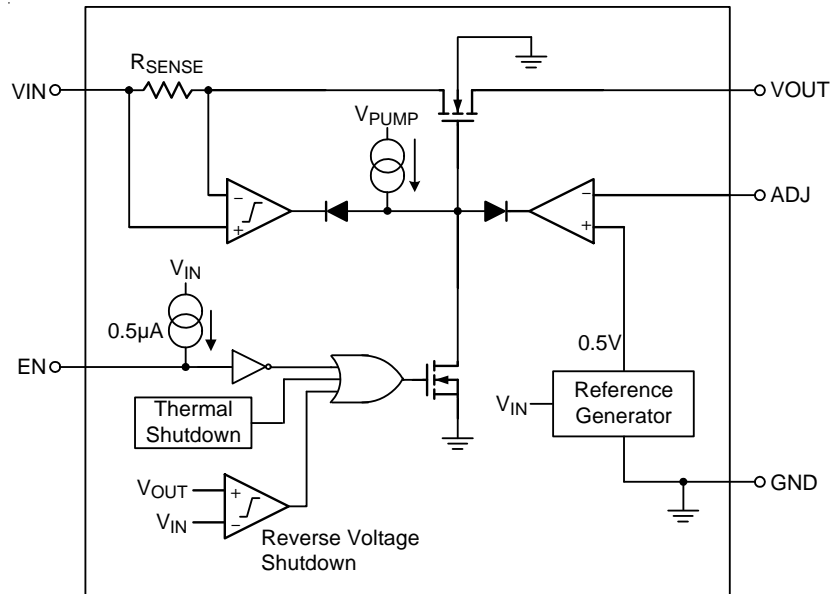

Operation

The RTQ9091 is a low input voltage low dropout LDO that can support the input voltage range from 1.4V to 6V and the output current can be up to 2A. The RTQ9091 uses internal charge pump to achieve low input voltage operation and the internal compensation network is well designed to achieve fast transient response with good stability. In steady-state operation, the feedback voltage is regulated to the reference voltage by the internal regulator. When the feedback voltage signal is less than the reference, the on resistance of the power MOSFET is decreased to increase the output current through the power MOSFET, and the feedback voltage will be charge back to reference. If the feedback voltage is less than the reference, the power MOSFET current is decreased to make the output voltage discharge back to reference by the loading current.

Reverse Current Protection

The reverse current protection is guarantee by the N-MOSFET with bulk capacitors connected to GND and the internal circuit. The reverse voltage detection circuit shuts the total loop down if the output voltage is higher than input voltage.

Output Under-Voltage Protection (UVP) and Over-Current Fold-Back

When the feedback voltage is lower than 0.15V after internal soft-start end, the UVP is triggered. If the over current condition is triggered during UVP state, the OC limit current will be decreased to limit the output power and change into re-soft-start state at the same time.

Soft-Start

An internal current source charges an internal capacitor to build the soft-start ramp voltage. During the soft-start state, the output current will be limited to prevent the inrush current.

Over-Temperature Protection (OTP)

When the device triggers the OTP, the device shuts down until the temperature back to normal and move to re-soft-start state.

Absolute Maximum Ratings (Note 1)

- Supply Voltage, V_{IN} ----- 0.3V to 7V
- Other Pins ----- 0.3V to 7V
- Power Dissipation, P_D @ $T_A = 25^\circ\text{C}$
 SOP-8 (Exposed Pad) ----- 2.500W
- Package Thermal Resistance (Note 2)
 SOP-8 (Exposed Pad), θ_{JA} ----- 40°C/W
 SOP-8 (Exposed Pad), θ_{JC} ----- 8°C/W
- Lead Temperature (Soldering, 10 sec.) ----- 260°C
- Junction Temperature ----- 150°C
- Storage Temperature Range ----- -65°C to 150°C
- ESD Susceptibility (Note 3)
 HBM (Human Body Model) ----- 2kV

Recommended Operating Conditions (Note 4)

- Supply Voltage, V_{IN} ----- 1.4V to 6V
- Junction Temperature Range ----- -40°C to 125°C

Electrical Characteristics

($V_{IN} = 1.4\text{V to }6\text{V}$, $I_{OUT} = 10\mu\text{A to }2\text{A}$, $V_{ADJ} = V_{OUT}$, $-40^\circ\text{C} \leq T_J \leq 85^\circ\text{C}$, unless otherwise specified)

Parameter	Symbol	Test Conditions	Min	Typ	Max	Unit
Quiescent Current	I_Q	$V_{IN} = 3.3\text{V}$, $I_{OUT} = 0\text{A}$	--	0.7	1.5	mA
Shutdown Current	I_{SHDN}	$V_{IN} = 6\text{V}$, $V_{EN} = 0\text{V}$	--	1.5	10	μA
Line Regulation	ΔV_{LINE}	$I_{OUT} = 10\text{mA}$	--	0.2	0.4	%/V
Load Regulation	ΔV_{LOAD}	$I_{OUT} = 10\text{mA to }2\text{A}$	--	0.5	1.5	%
Dropout Voltage	V_{DROP}	$I_{OUT} = 1\text{A}$, $V_{IN} \geq 1.6\text{V}$	--	120	200	mV
		$I_{OUT} = 1\text{A}$, $1.4\text{V} < V_{IN} < 1.6\text{V}$	--	--	400	
		$I_{OUT} = 1.5\text{A}$, $V_{IN} \geq 1.6\text{V}$	--	180	300	
		$I_{OUT} = 1.5\text{A}$, $1.4\text{V} < V_{IN} < 1.6\text{V}$	--	--	500	
		$I_{OUT} = 2\text{A}$, $V_{IN} \geq 1.6\text{V}$	--	240	400	
		$I_{OUT} = 2\text{A}$, $1.4\text{V} < V_{IN} < 1.6\text{V}$	--	--	600	
Current Limit	I_{LIM}	$V_{IN} = 3.3\text{V}$	2.3	3	4.4	A
Feedback						
ADJ Reference Voltage	V_{REF}	$V_{IN} = 3.3\text{V}$, $V_{ADJ} = V_{OUT}$, $I_{OUT} = 10\text{mA}$, $T_A = 25^\circ\text{C}$	0.495	--	0.505	V
		$V_{IN} = 3.3\text{V}$, $V_{ADJ} = V_{OUT}$, $I_{OUT} = 10\text{mA}$	0.4925	--	0.5075	
ADJ Pin Current	I_{ADJ}	$V_{ADJ} = 0.5\text{V}$	--	20	200	nA

Parameter	Symbol	Test Conditions	Min	Typ	Max	Unit	
Enable							
EN Pin Current	I _{EN}	V _{EN} = 0V, V _{IN} = 6V	--	1	10	μA	
EN Threshold Voltage	Logic-High	V _{IH}	V _{IN} = 3.3V	1.6	--	--	V
	Logic-Low	V _{IL}	V _{IN} = 3.3V	--	--	0.4	
Over-Temperature Protection							
OTP Trip Level			--	160	--	°C	
Hysteresis			--	30	--	°C	

Note 1. Stresses beyond those listed under “Absolute Maximum Ratings” may cause permanent damage to the device. These are stress ratings only, and functional operation of the device at these or any other conditions beyond those indicated in the operational sections of the specifications is not implied. Exposure to absolute maximum rating conditions may affect device reliability.

Note 2. θ_{JA} is measured in the natural convection (air flow = 0 ft/min) at T_A = 25°C on a highly thermal conductive four-layer test board of JEDEC 51-7 thermal measurement standard. The test board size is 75.6mm x 114.3mm (3"x4.5") with 1.6mm thickness FR4 refer to JEDEC 51 standard. The test board exist four-layer copper, 2oz. (0.07mm) thickness. The case point of θ_{JC} is on the expose pad for SOP-8 (Exposed Pad) package. The copper area of top copper plane is about 100mm².

Note 3. Devices are ESD sensitive. Handling precaution is recommended.

Note 4. The device is not guaranteed to function outside its operating conditions.

Typical Application Circuit

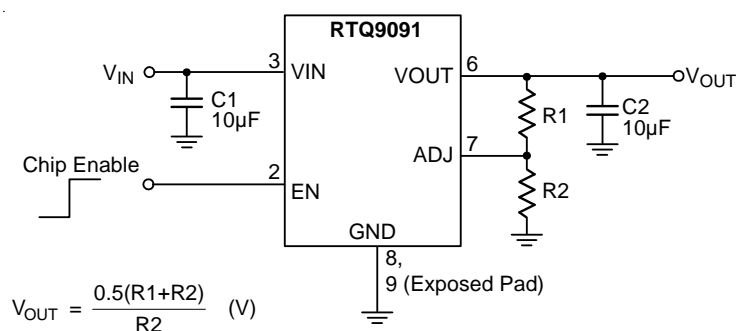

Typical Operating Characteristics

Reference Voltage vs. Temperature

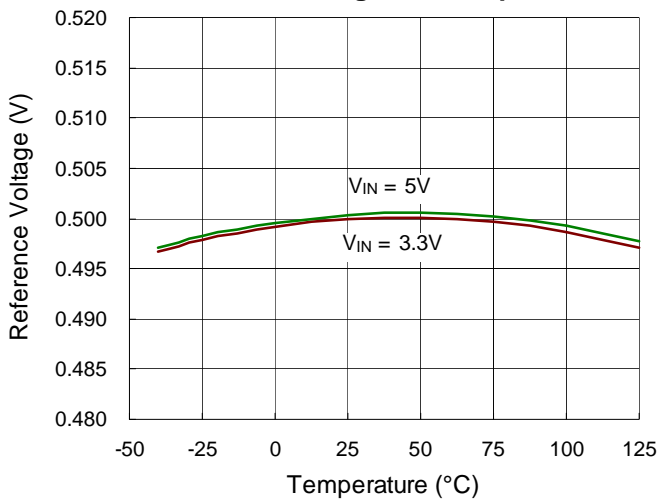

Quiescent Current vs. Temperature

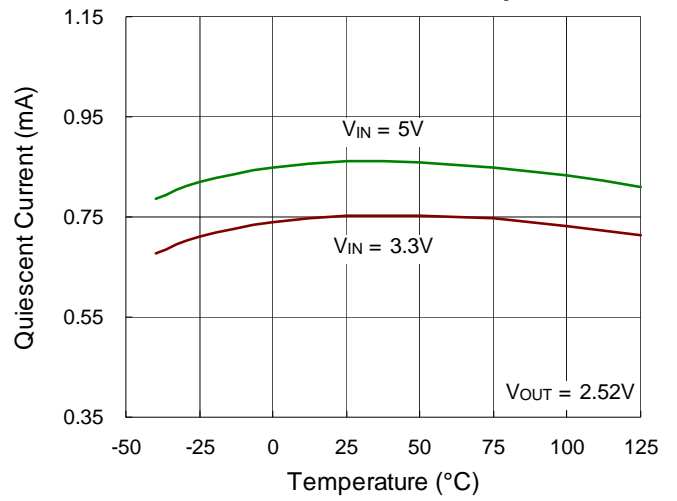

Shutdown Current vs. Temperature

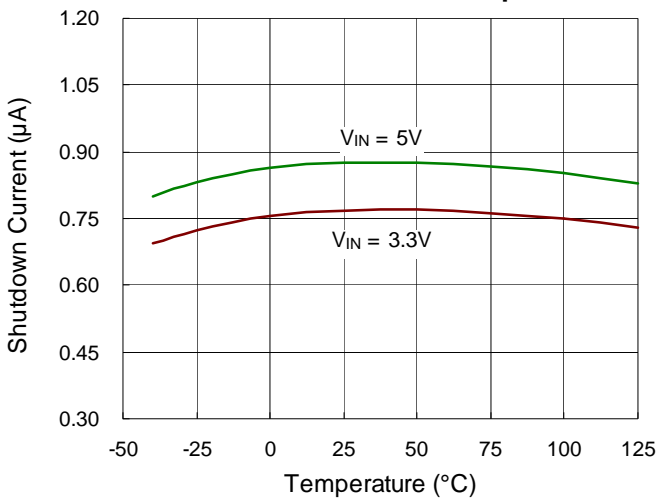

UVLO vs. Temperature

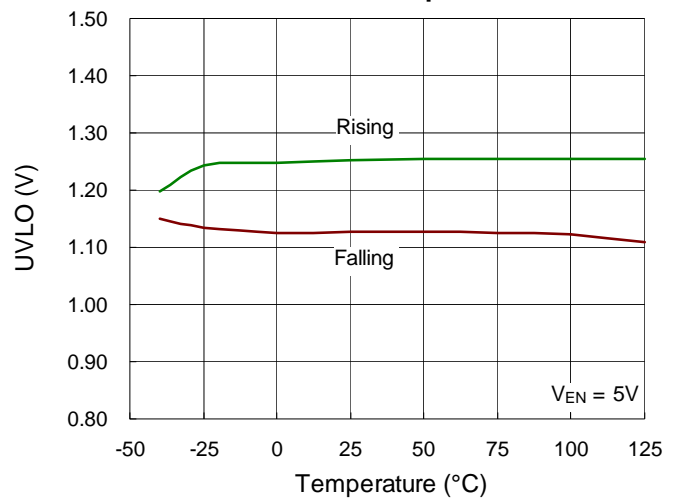

Dropout Voltage vs. Load Current

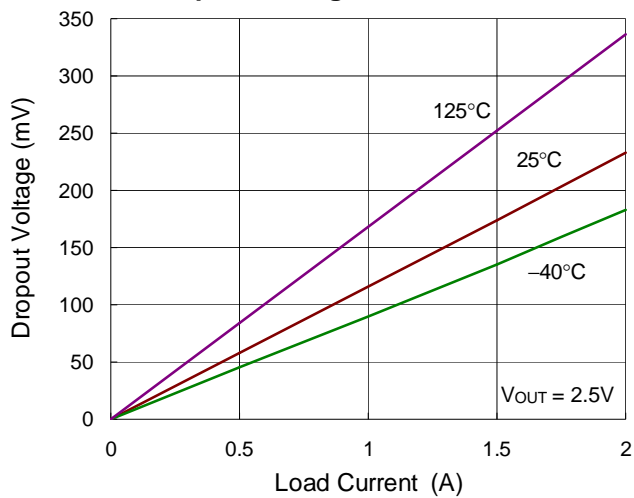

EN Threshold Voltage vs. Temperature

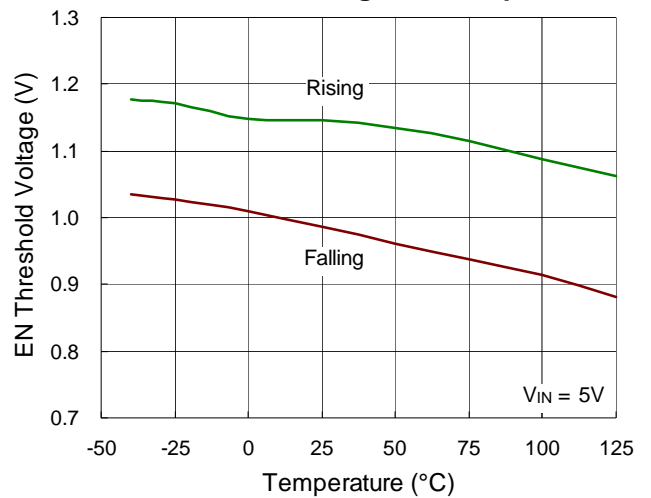

Load Transient Response

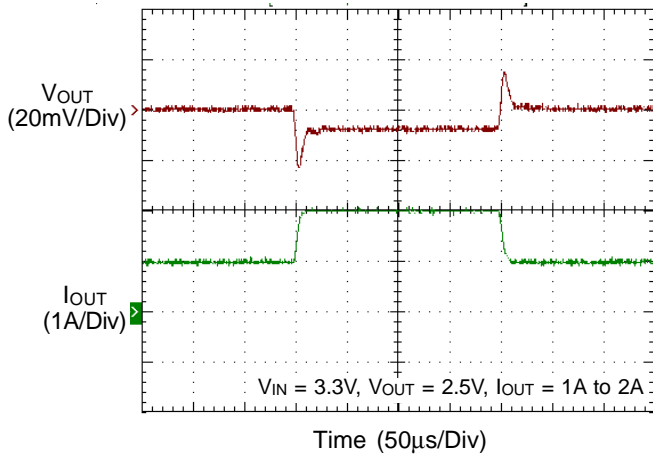

Line Transient Response

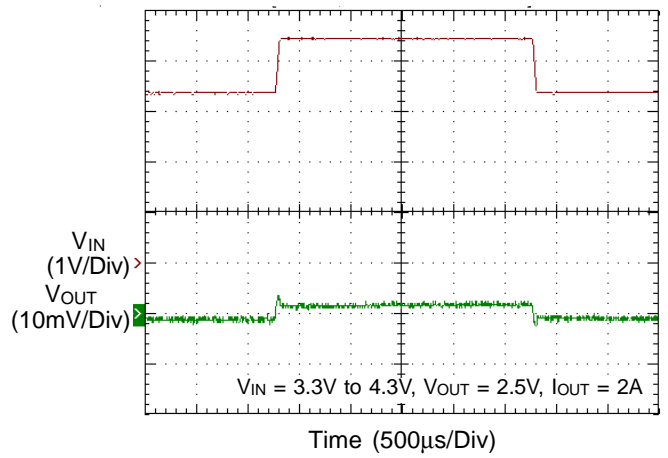

Power On from EN

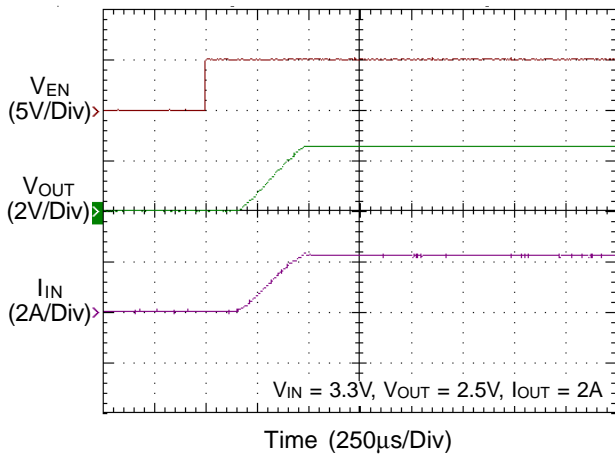

Power Off from EN

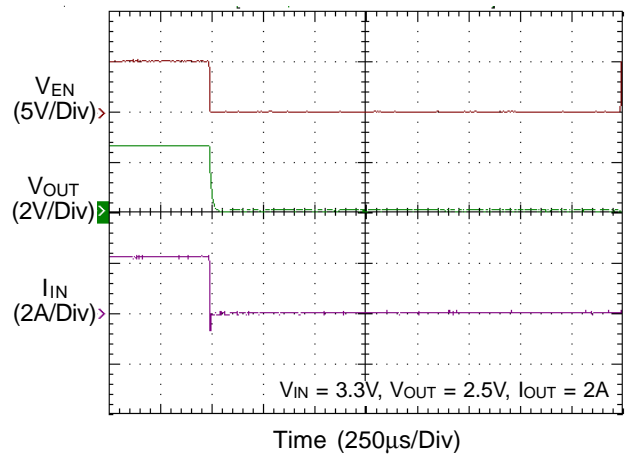

PSRR

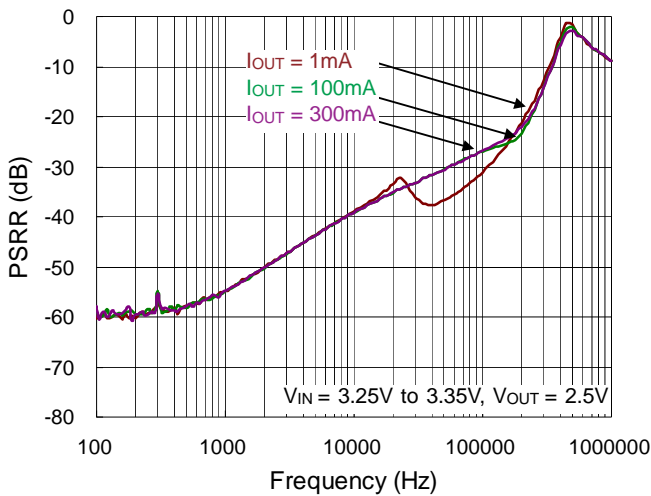

VEN Rising vs. Input Voltage

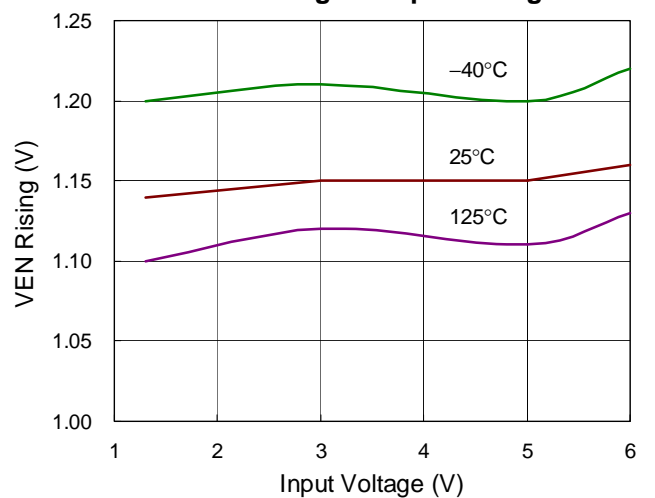

Application Information

The RTQ9091 is a low voltage, low dropout linear regulator with an external bias supply input capable of supporting an input voltage range from 1.4V to 6V.

Output Voltage Setting

The RTQ9091 output voltage is adjustable from 0.5V to ($V_{IN} - V_{DROP}$) via the external resistive voltage divider. The voltage divider resistors can have values of up to 800k Ω because of the very high impedance and low bias current of the sense comparator. The output voltage is set according to the following equation :

$$V_{OUT} = V_{REF} \times \left(1 + \frac{R1}{R2} \right)$$

where V_{REF} is the reference voltage with a typical value of 0.5V.

Chip Enable Operation

The RTQ9091 goes into sleep mode when the EN pin is in a logic low condition. In this condition, the pass transistor, error amplifier, and band gap are all turned off, reducing the supply current to only 10 μ A (max.). The EN pin can be directly tied to V_{IN} to keep the part on.

Current Limit

The RTQ9091 contains an independent current limit circuitry, which monitors and controls the pass transistor's gate voltage, limiting the output current to 3A (typ.).

C_{IN} and C_{OUT} Selection

The RTQ9091 is designed to support the low equivalent series resistance (ESR) ceramic capacitors for application. The X7R, X5R, and COG-rated ceramic capacitors are recommended due to their good capacitive stability across temperature, whereas the use of Y5V-rated capacitors is discouraged because of large variations in capacitance. However, ceramic capacitance varies with operating voltage and temperature and the design engineer must be aware of these characteristics. It is recommended to use an output capacitor not less than 10 μ F to ensure stability.

Input capacitance is selected to minimize transient input droop during load current steps. For general applications, an input capacitor of at least 10 μ F is highly recommended for minimal input impedance. If the trace inductance between the RTQ9091 input supply is high, a fast load transient may cause V_{IN} voltage level ringing and above the absolute maximum voltage rating that also damages the device. Adding more input capacitors is available to restrict the ringing and to keep it not above the device absolute maximum ratings. Place these capacitors as close to the pins as possible for optimum performance and to help ensure stability.

Thermal Considerations

Thermal protection limits power dissipation in the RTQ9091. When the operation junction temperature exceeds 160 $^{\circ}$ C, the OTP circuit starts the thermal shutdown function and turns the pass element off. The pass element turns on again after the junction temperature cools by 30 $^{\circ}$ C.

The RTQ9091 output voltage will be closed to zero when output short circuit occurs as shown in Figure 1. It can reduce the IC temperature and provides maximum safety to end users when output short circuit occurs.

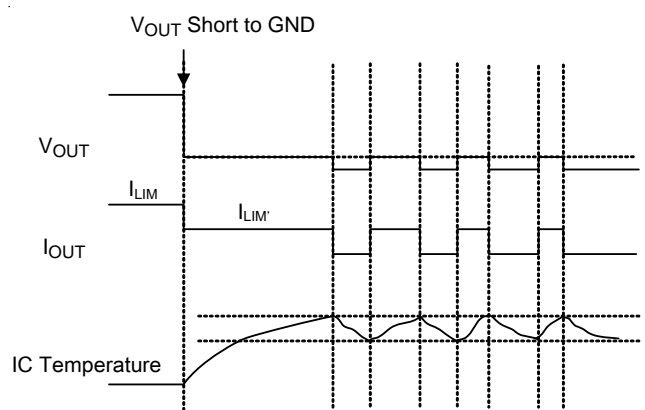

Figure 1. Short Circuit Protection when Output Short Circuit Occurs

The junction temperature should never exceed the absolute maximum junction temperature $T_{J(MAX)}$, listed under Absolute Maximum Ratings, to avoid permanent damage to the device. The maximum allowable power dissipation depends on the thermal resistance of the IC package, the PCB layout, the rate of surrounding airflow, and the difference between the junction and ambient temperatures. The maximum power dissipation can be calculated using the following formula :

$$P_{D(MAX)} = (T_{J(MAX)} - T_A) / \theta_{JA}$$

where $T_{J(MAX)}$ is the maximum junction temperature, T_A is the ambient temperature, and θ_{JA} is the junction-to-ambient thermal resistance.

For continuous operation, the maximum operating junction temperature indicated under Recommended Operating Conditions is 125°C. The junction-to-ambient thermal resistance, θ_{JA} , is highly package dependent. For a SOP-8 (Exposed Pad) package, the thermal resistance, θ_{JA} , is 40°C/W on a standard JEDEC 51-7 high effective-thermal-conductivity four-layer test board. The maximum power dissipation at $T_A = 25^\circ\text{C}$ can be calculated as below :

$$P_{D(MAX)} = (125^\circ\text{C} - 25^\circ\text{C}) / (40^\circ\text{C/W}) = 2.500\text{W for a SOP-8 (Exposed Pad) package.}$$

The maximum power dissipation depends on the operating ambient temperature for the fixed $T_{J(MAX)}$ and the thermal resistance, θ_{JA} . The derating curves in Figure 2 allows the designer to see the effect of rising ambient temperature on the maximum power dissipation.

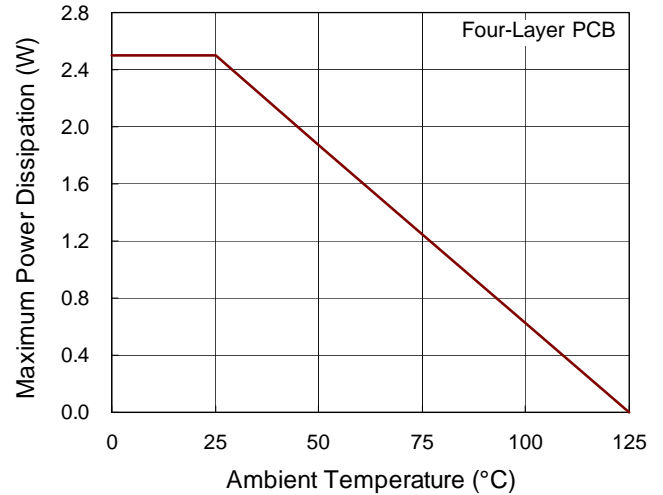
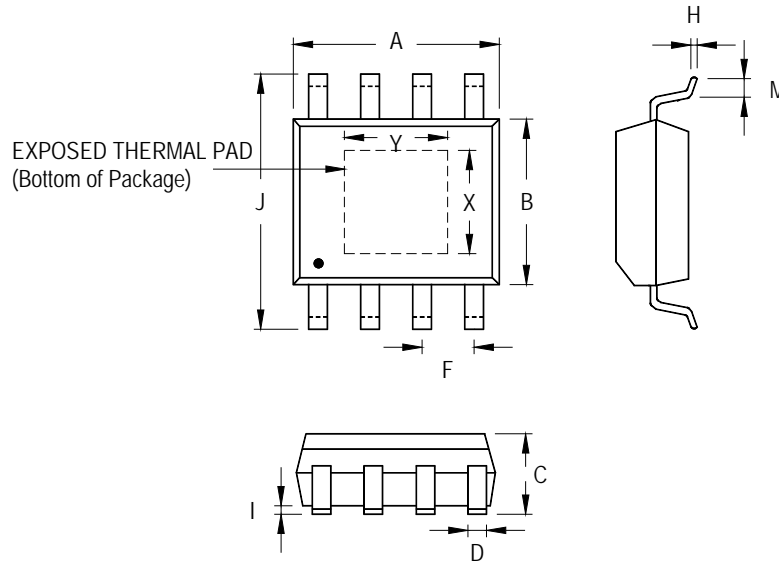

Figure 2. Derating Curve of Maximum Power Dissipation

Outline Dimension



Symbol	Dimensions In Millimeters		Dimensions In Inches		
	Min	Max	Min	Max	
A	4.801	5.004	0.189	0.197	
B	3.810	4.000	0.150	0.157	
C	1.346	1.753	0.053	0.069	
D	0.330	0.510	0.013	0.020	
F	1.194	1.346	0.047	0.053	
H	0.170	0.254	0.007	0.010	
I	0.000	0.152	0.000	0.006	
J	5.791	6.200	0.228	0.244	
M	0.406	1.270	0.016	0.050	
Option 1	X	2.000	2.300	0.079	0.091
	Y	2.000	2.300	0.079	0.091
Option 2	X	2.100	2.500	0.083	0.098
	Y	3.000	3.500	0.118	0.138

8-Lead SOP (Exposed Pad) Plastic Package

Footprint Information

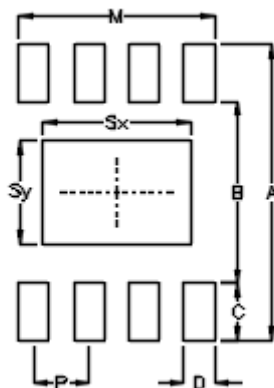

Package		Number of Pin	Footprint Dimension (mm)							Tolerance	
			P	A	B	C	D	Sx	Sy		M
PSOP-8	Option1	8	1.27	6.80	4.20	1.30	0.70	2.30	2.30	4.51	±0.10
	Option2							3.40	2.40		

Richtek Technology Corporation

14F, No. 8, Tai Yuen 1st Street, Chupei City

Hsinchu, Taiwan, R.O.C.

Tel: (8863)5526789

Richtek products are sold by description only. Customers should obtain the latest relevant information and data sheets before placing orders and should verify that such information is current and complete. Richtek cannot assume responsibility for use of any circuitry other than circuitry entirely embodied in a Richtek product. Information furnished by Richtek is believed to be accurate and reliable. However, no responsibility is assumed by Richtek or its subsidiaries for its use; nor for any infringements of patents or other rights of third parties which may result from its use. No license is granted by implication or otherwise under any patent or patent rights of Richtek or its subsidiaries.