

RTQ2131B, 36V, 1A, Synchronous Step-Down Converter Evaluation Board

General Description

The Evaluation Board demonstrates the RTQ2131B to be designed for a 5V/1.0A output from a 7V to 25V input at 2.1MHz switching frequency. The RTQ2131B can apply to other output voltages by changing the resistive divider for input voltages support up to 36V. For more application circuits, please refer to the RTQ2131B datasheet. The wide input range makes it suitable for automotive systems and car camera module. The RTQ2131B provides complete protection functions such as input under-voltage lockout, output under-voltage protection, over-current protection, and thermal shutdown. Cycle-by-cycle current limit provides protection against shorted outputs and soft-start eliminates input current surge during start-up.

Table of Contents

General Description	1
Performance Sepcification Summary	2
Power-up Procedure	2
Detailed Description of Hardware	3
Bill of Materials	5
Typical Applications	6
Evaluation Board Layout.....	9
More Information.....	11
Important Notice for Richtek Evaluation Board	11

Performance Specification Summary

Summary of the RTQ2131B Evaluation Board performance specification is provided in Table 1. The ambient temperature is 25°C.

Table 1. RTQ2131BGQW Evaluation Board Performance Specification Summary

Specification	Test Conditions	Min	Typ	Max	Unit
Input Voltage Range	$V_{OUT} = 5V$	7	--	25	V
Output Current		0	--	1	A
Default Output Voltage		--	5	--	V
Operation Frequency		--	2100	--	kHz
Output Ripple Voltage	$I_{OUT} = 1A$	--	10	--	mVp-p
Line Regulation	$I_{OUT} = 1A, V_{IN} = 7V \text{ to } 25V$	--	± 1	--	%
Load Regulation	$V_{IN} = 12V, I_{OUT} = 0.001 \text{ A to } 1A$	--	± 1	--	%
Load Transient Response	$I_{OUT} = 0A \text{ to } 1A$	--	± 5	--	%
Maximum Efficiency	$V_{IN} = 12V, V_{OUT} = 5V, I_{OUT} = 1A$	--	89.3	--	%

Power-up Procedure

Suggestion Required Equipments

- RTQ2131B Evaluation Board
- DC power supply capable of at least 36V and 1A
- Electronic load capable of 6A
- Function Generator
- Oscilloscope

Quick Start Procedures

The Evaluation Board is fully assembled and tested. Follow the steps below to verify board operation. Caution : Do not turn on supplies until all connections are made. Note: When measuring the output voltage ripple, care must be taken to avoid a long ground lead on the oscilloscope probe. Measure the output voltage ripple by touching the probe tip and ground ring directly across the last output capacitor.

Proper measurement equipment setup and follow the procedure below.

- 1) With power off, connect the input power supply to VIN and GND pins.
- 2) With power off, connect the electronic load between the VOUT and nearest GND pins.
- 3) Turn on the power supply at the input. Make sure that the input voltage does not exceeds 36V on the Evaluation Board.
- 4) Check for the proper output voltage using a voltmeter.
- 5) Once the proper output voltage is established, adjust the load within the operating ranges and observe the output voltage regulation, ripple voltage, efficiency and other performance.

Detailed Description of Hardware

Headers Description and Placement

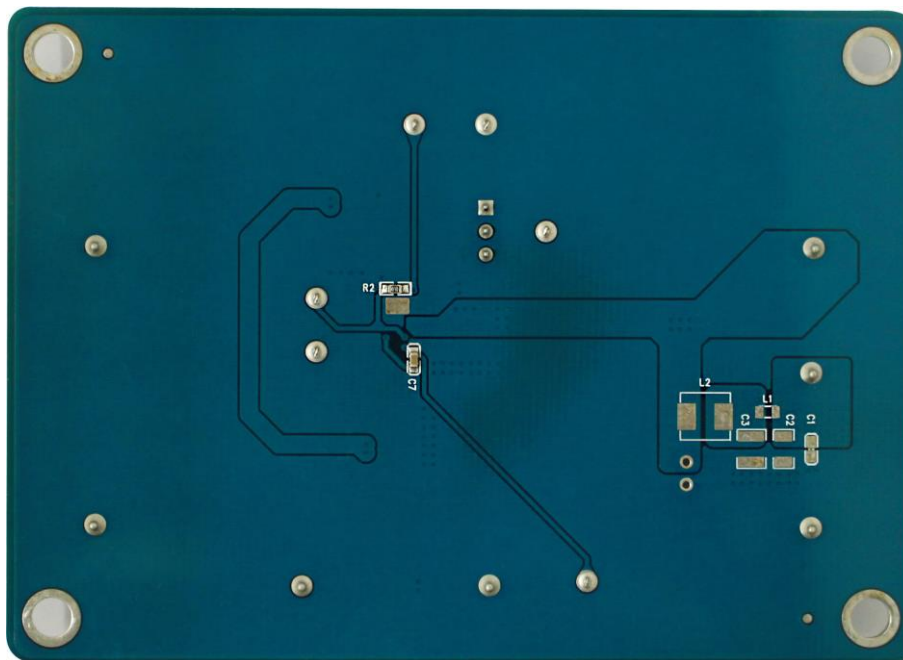
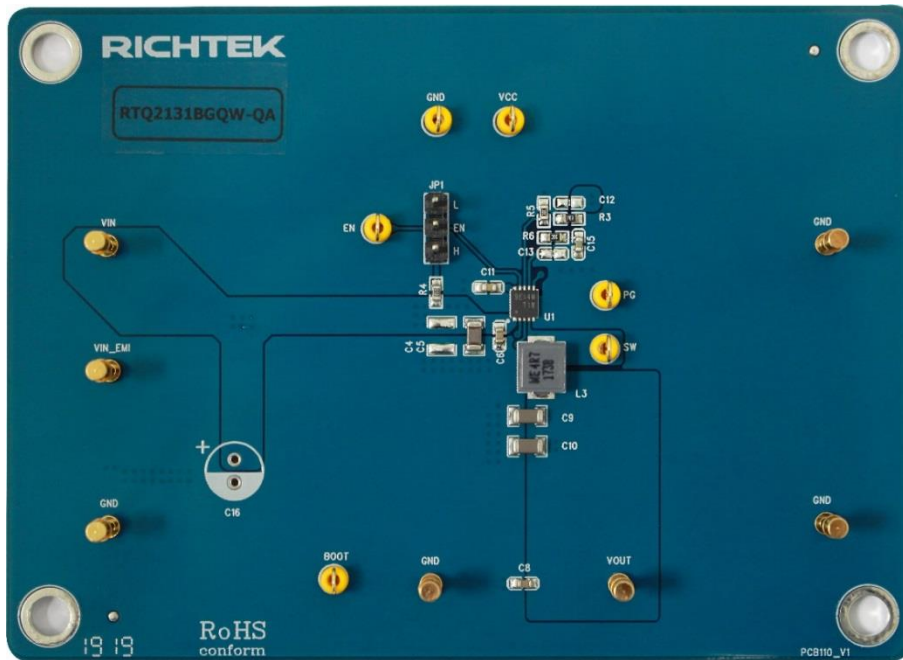

Carefully inspect all the components used in the EVB according to the following Bill of Materials table, and then make sure all the components are undamaged and correctly installed. If there is any missing or damaged component, which may occur during transportation, please contact our distributors or e-mail us at evb_service@richtek.com.

Test Points

The EVB is provided with the test points and pin names listed in the table below.

Test Point/ Pin Name	Function
VIN	Input voltage positive connection. The power supply must be connected to input connectors, VIN and GND.
EN	Enable test point. The test point can be used to measure the enable signal.
VOUT	Output voltage connection. The load must be connected to output connectors, VOUT and GND.
JP1	EN jumper. Connect EN to ground to disable, connect EN to logic high to enable.
PG	Power-good indication test point. The test point can be used to measure the power-good signal.
GND	Ground. Input/Output voltage return connection.
BOOT	Bootstrap node test point. The test point can be used to measure the bootstrap voltage.
SW	Switch node test point. The test point can be used to measure the switching node.
VIN_EMI	Input voltage node before EMI solution. Optional for EMI requirement.
VCC	Linear regulator output test point. The test point can be used to measure the output node of the internal regulator.

Bill of Materials

V _{IN} = 12V, V _{OUT} = 5V, I _{OUT} = 1A, f _{sw} = 2100kHz						
Reference	Count	Part Number	Value	Description	Package	Manufacturer
U1	1	RTQ2131BGQW-QA	RTQ2131B	Step-Down Converter	WDFN-10SL 3x3	RICHTEK
C1, C2, C3, C4, C16	5	N/A	N/A	Optional for EMI requirement	N/A	N/A
C5	1	GCM31CR71H225KA	2.2μF	Capacitor, ceramic, 50V, X7R, ±10%	1206	MURATA
C6, C7, C8	3	CGA3E2X7R1H104K	0.1μF	Capacitor, ceramic, 50V, X7R, ±10%	0603	TDK
C9, C10	2	GCM31CC71E106KA	10μF	Capacitor, ceramic, 25V, X7S, ±10%	1206	MURATA
C11	1	GCM188R71C105KA	1μF	Capacitor, ceramic, 16V, X7R, ±10%	0603	MURATA
C12	1	N/A	N/A	Optional	N/A	N/A
C13	1	N/A	N/A	Optional	N/A	N/A
C15	1	GCE188R71H152KA	1.5nF	Capacitor, ceramic, 50V, X7R, ±10%	0603	N/A
L1, L2	2	N/A	N/A	Optional for EMI requirement	N/A	N/A
L3	1	WE-74437336047	4.7μH	Inductor, SMT, Isat = 5.9A, 50mΩ	5.2 x 5.2 x 2.8mm	Würth Elektronik
R2, R4	2	WR06X1003	100kΩ	Resistor, chip, 1/10W, 1%	0603	WALSIN
R3	1	WR06X1053	105k	Resistor, chip, 1/10W, 1%	0603	WALSIN
R5	1	WR06X2002	20k	Resistor, chip, 1/10W, 1%	0603	WALSIN
R6	1	WR06X3742	37.4k	Resistor, chip, 1/10W, 1%	0603	WALSIN

Typical Applications

EVB Schematic Diagram

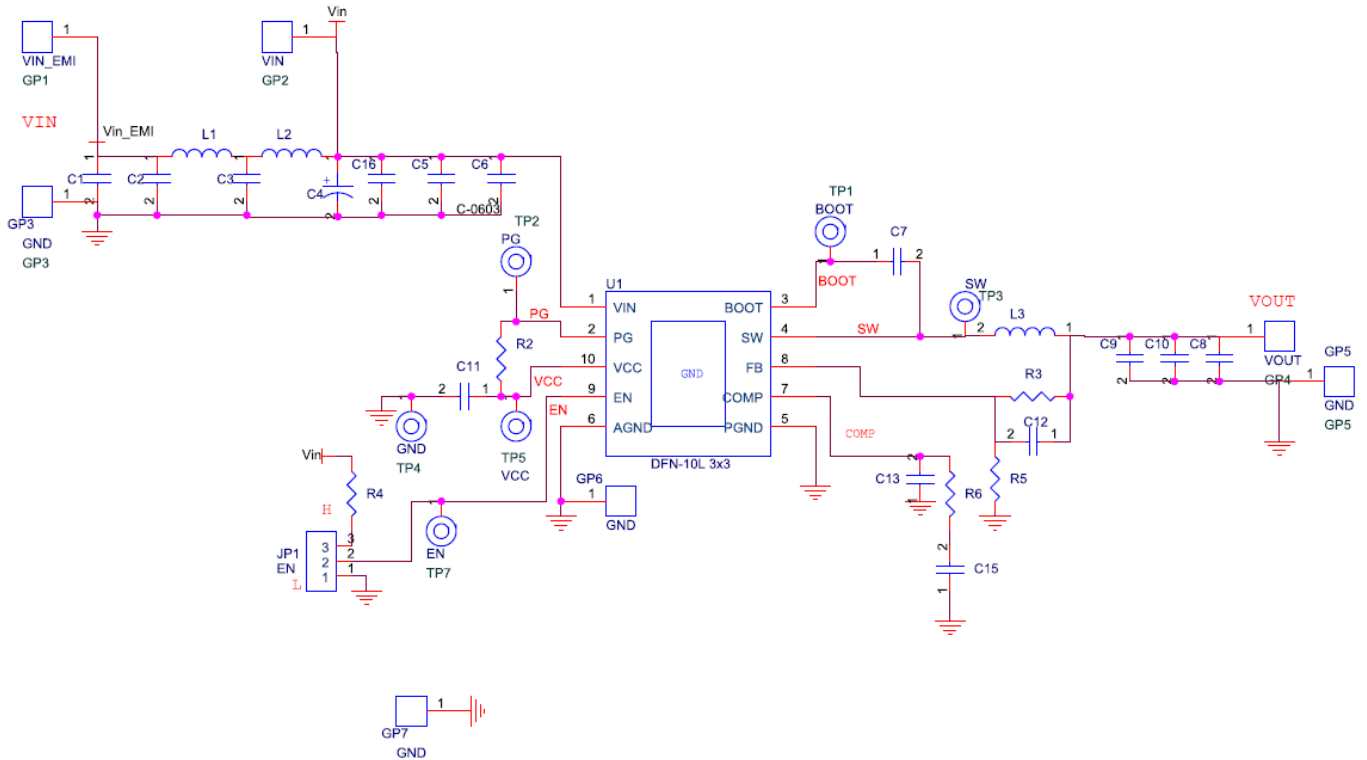

1. The capacitance values of the input and output capacitors will influence the input and output voltage ripple.
2. MLCC capacitors have degrading capacitance at DC bias voltage, and especially smaller size MLCC capacitors will have much lower capacitance.

Measure Result

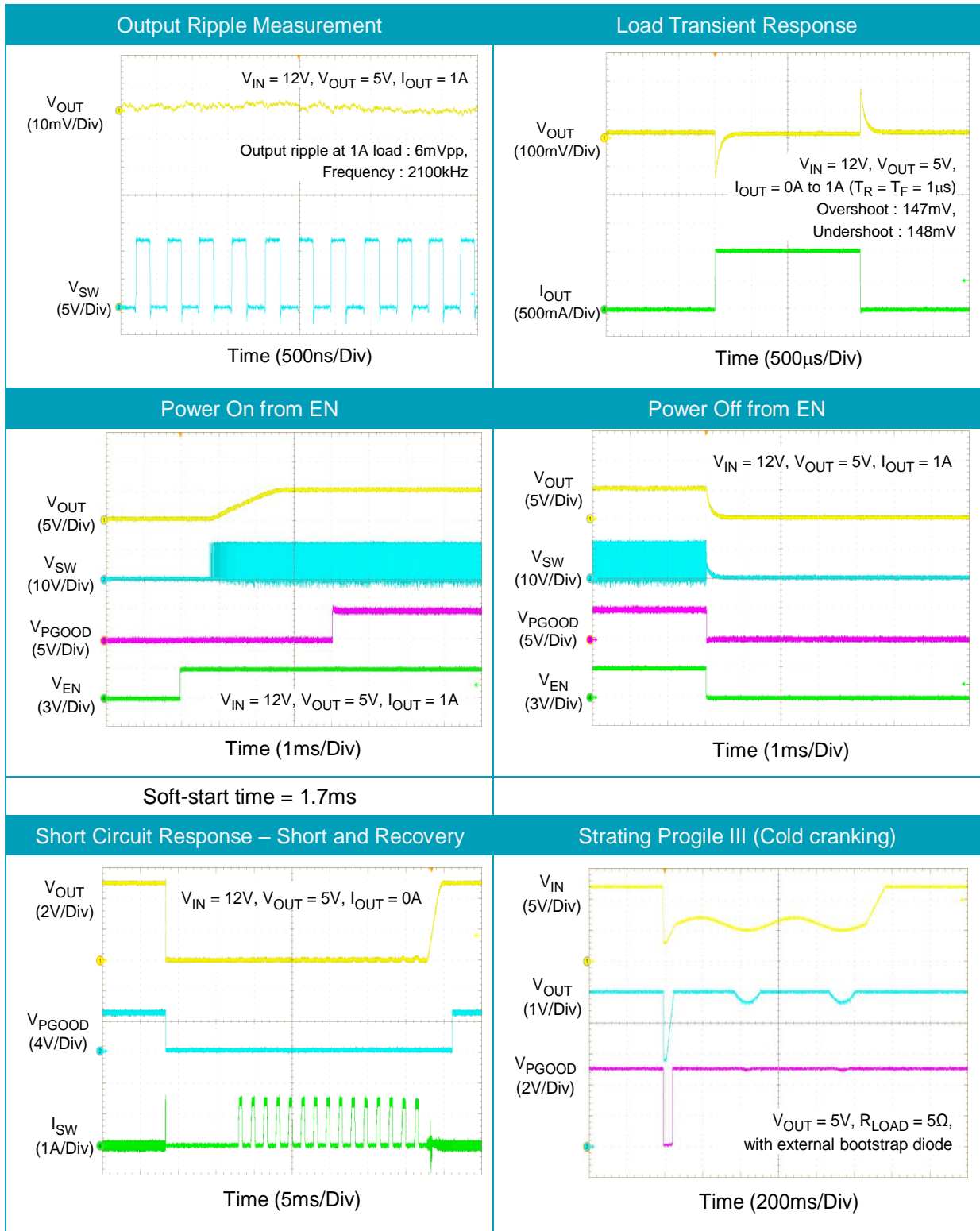

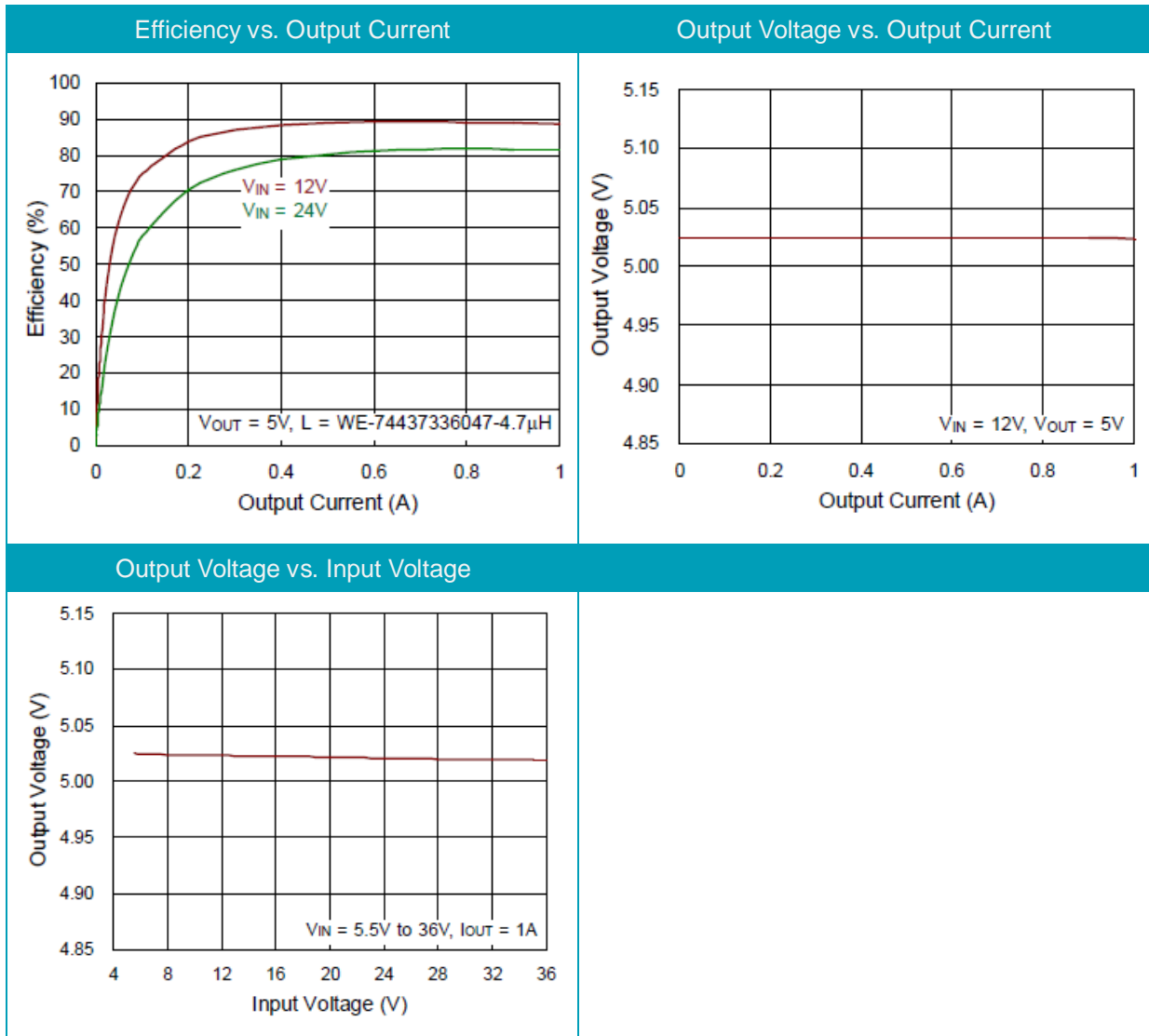

Note : When measuring the input or output voltage ripple, care must be taken to avoid a long ground lead on the oscilloscope probe. Measure the output voltage ripple by touching the probe tip directly across the output capacitor.

Evaluation Board Layout

Figure 1 to Figure 4 are RTQ2131B Evaluation Board layout. This board size is 110mm x 80mm and is constructed on four-layer PCB with 1 OZ. Cu on the outer layers and 1 OZ. Cu in the inner layers.

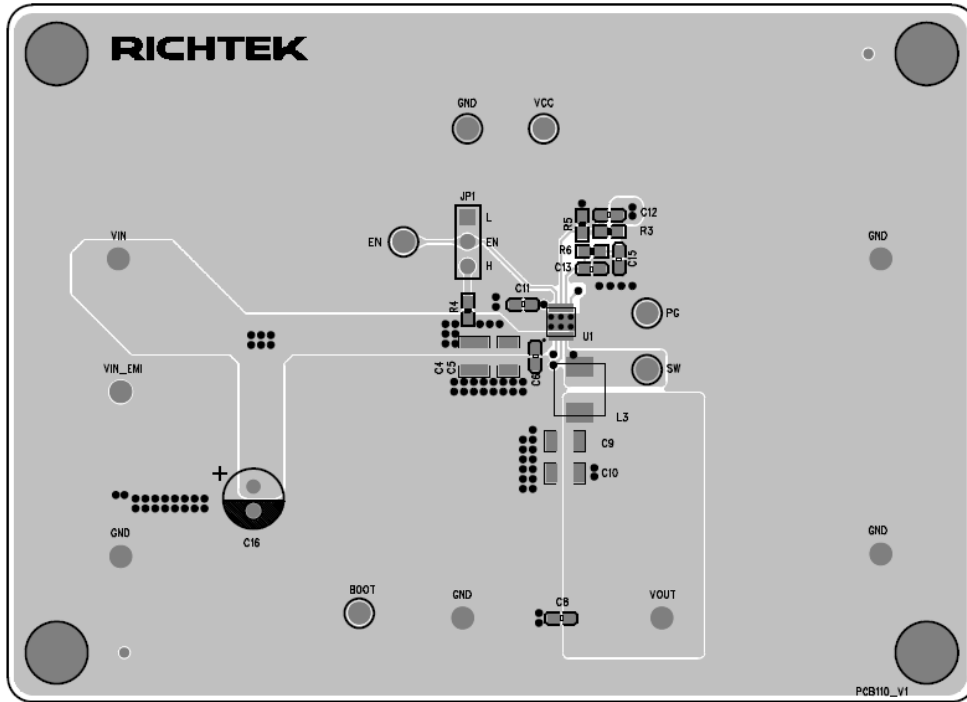

Figure 1. Top View (1st layer)

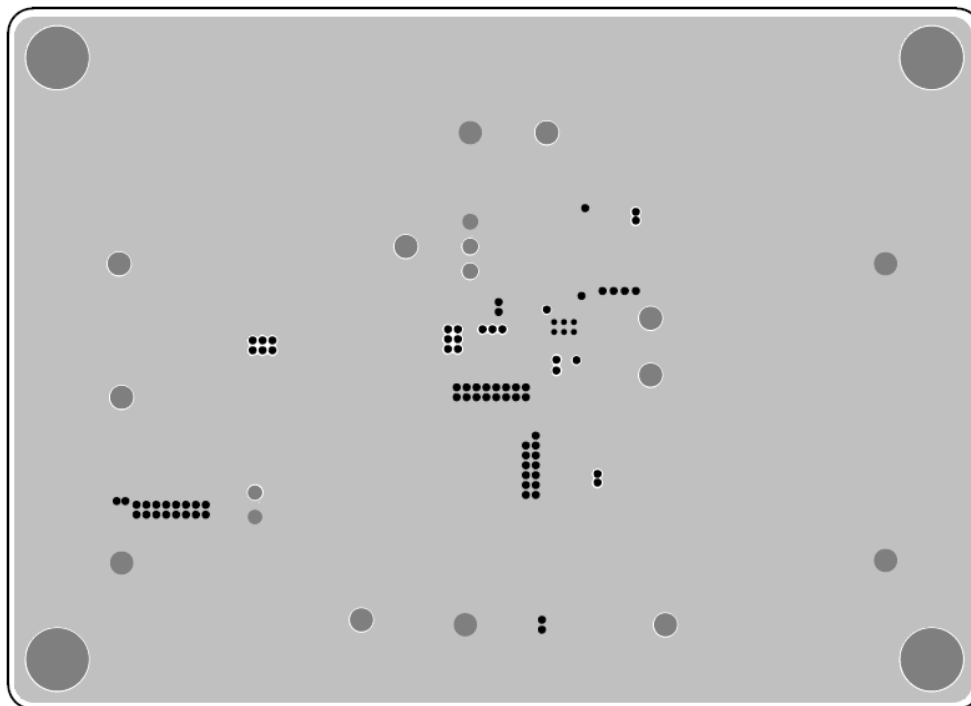

Figure 2. PCB Layout—Inner Side (2nd Layer)

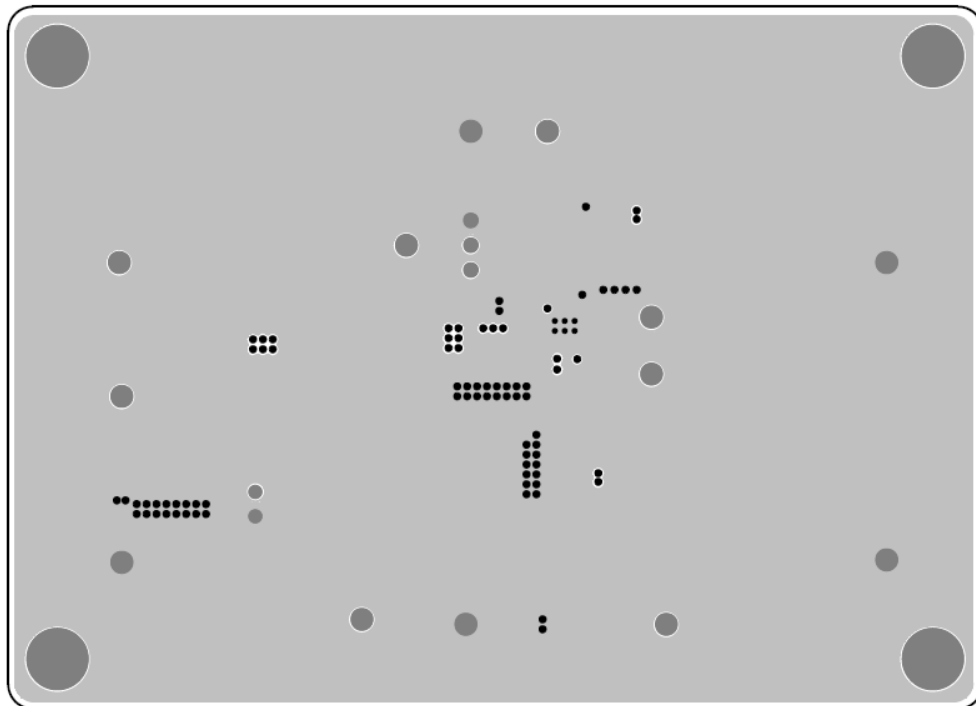

Figure 3. PCB Layout—Inner Side (3rd Layer)

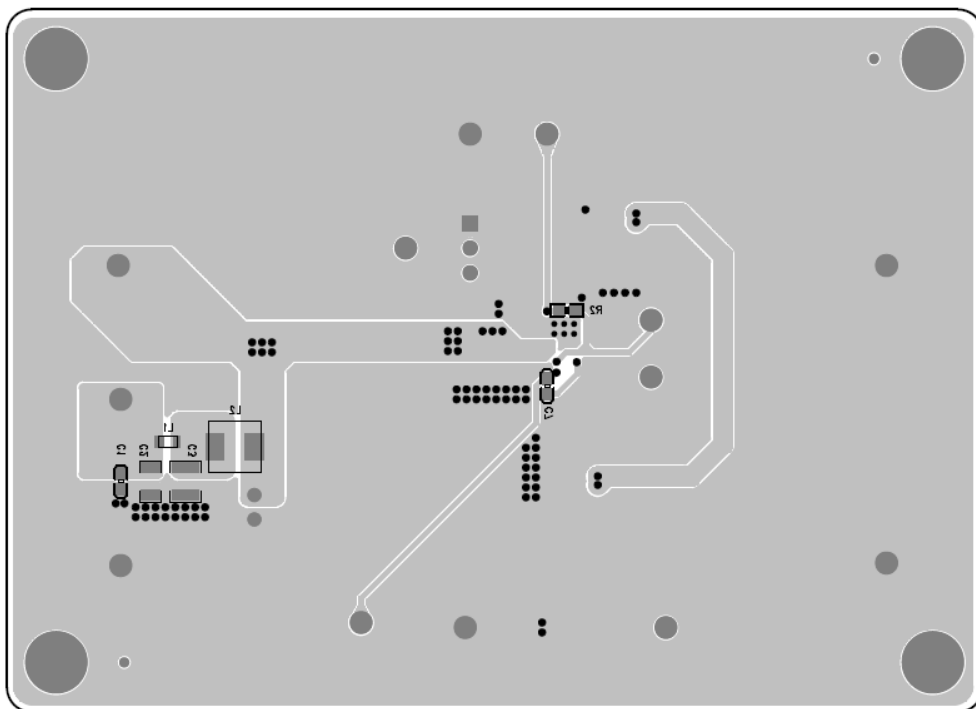

Figure 4. Bottom View (4th Layer)

More Information

For more information, please find the related datasheet or application notes from Richtek website <http://www.richtek.com>.

Important Notice for Richtek Evaluation Board

THIS DOCUMENT IS FOR REFERENCE ONLY, NOTHING CONTAINED IN THIS DOCUMENT SHALL BE CONSTRUED AS RICHTEK'S WARRANTY, EXPRESS OR IMPLIED, UNDER CONTRACT, TORT OR STATUTORY, WITH RESPECT TO THE PRESENTATION HEREIN. IN NO EVENT SHALL RICHTEK BE LIABLE TO BUYER OR USER FOR ANY AND ALL DAMAGES INCLUDING WITHOUT LIMITATION TO DIRECT, INDIRECT, SPECIAL, PUNITIVE OR CONSEQUENTIAL DAMAGES.